

Technical Information

Steering

OSPM Mini-Steering Unit



Revision history

Table of revisions

Date	Changed	Rev
March 2016	Updated to Engineering Tomorrow design	0403
August 2014	pressure updated	DB
July 2014	Changed to Danfoss layout	DA
November 2009	Steering column deleted	CA
April 2009		BA
March 2003	First version	AA

Contents

A wide range of Steering Components

Conversion factors.....	5
Survey of literature with technical data on Danfoss Steering Components.....	5

Steering unit OSPM

General.....	6
Introduction.....	6
Application.....	6
Advantages.....	6
Function.....	6
Versions.....	6
OSPM ON.....	7
OSPM PB.....	8
OSPM LS.....	9
Code numbers.....	9
OSPM open center non-reaction steering units.....	9
OSPM power beyond steering units.....	10
OSPM load sensing steering units.....	11
OSPMS sideported steering units.....	11
Order specification.....	12
Specification table none catalogue for numbers of OSPM steering units.....	12
Technical data.....	12
Common data.....	12
Displacement, flow and pressure OSPM ON/PB.....	13
Displacement, flow and pressure OSPM LS.....	13
Manual steering pressure.....	13
Valve function in OSPM steering units.....	14
Pressure relief valve.....	14
Pilot pressure relief valve.....	15
Shock valves.....	15
Check valve.....	15
Pressure drop in neutral.....	15
Port connections.....	16
Dimensions.....	17
OSPM dimensions.....	17
OSPMS dimensions.....	19

Steering column for OSPM

Load on integrated steering column.....	21
Load on the steering unit column.....	21
Installing the steering column.....	21

A wide range of Steering Components



F500 026

Danfoss is one of the largest producers in the world of steering components for hydrostatic steering systems on off-road vehicles. Danfoss offers steering solutions both at component and system levels. Our product range makes it possible to cover applications of all types - ranging from ordinary 2-wheel steering (also known as Ackermann steering) to articulated steering, automatic steering (e.g. by sensor) and remote controlled steering via satellite. We can offer more than 1,800 different steering units and 250 different priority valves categorized in types, variants and sizes.

For hydrostatic steering systems Danfoss offers:

- Mini steering units with displacements from 32 to 100 cm³/rev [1.95 to 6.10 in³/rev], flow up to 20 l/min [5.28 US gal/min], steering pressure up to 140 bar [2030 psi].
- Steering units with displacements from 40 to 1200 cm³/rev [2.44 to 73.2 in³/rev], flow up to 100 l/min [26.4 US gal/min], steering pressure up to 240 bar [3481 psi].
- Priority valves for rated flows at 40, 80, 120, 160 and 320 l/min [10.6, 21.1, 31.7, 42.3 and 84.5 US gal/min], pressure up to 350 bar [5076 psi].
- Pilot operated flow-amplifiers with amplification factors of 4, 5, 8, 10 or 20 for rated oil flows of 240 and 400 l/min [63.4 and 105.7 US gal/min], steering pressure up to 210 bar [3045 psi].
- Pilot operated steering valve with steering flow up to 100 l/min [26.4 US gal/min], steering pressure up to 250 bar [3625 psi] and with integrated priority valve for pump flow up to 120 l/min [31.7 US gal/min].

For electrohydraulic steering systems Danfoss offers:

- Pilot operated steering valves (pilot operated by hydrostatic steering unit or by electrical signal) with steering flows up to 100 l/min [26.4 US gal/min], steering pressure up to 250 bar [3625 psi].
- Steering units with integrated electrical operated steering valve with steering flow up to 50 l/min [13.2 US gal/min], steering pressure up to 210 bar [3045 psi].

A wide range of Steering Components

Characteristic features for steering units:

- Low steering torque: From 0.5 N•m to 3 N•m in normal steering situations
- Low noise level
- Low pressure drop
- Many types available: Open center Non-reaction, Open center Reaction, Power Beyond, Closed center Non-reaction, Load Sensing, Load Sensing Reaction
- One or more built-in valve functions: relief valve, shock valves, suction valves, non-return valve in P-line and in LS-line
- Optional port connections (according to ISO, SAE or DIN standards)

Characteristic features for electrohydraulic steering systems with OSPE and EHPS:

- Possibility of GPS, row sensor, variable steering ratio and joystick steering
- The possibility of manual steering even on very heavy vehicles
- EHPS: High steering pressure requiring smaller cylinders and flow
- EHPS: Low pilot pressure and flow giving extremely low noise in the cabin
- EHPS: Can be combined with Danfoss PVG 32 proportional valve

Conversion factors

$$1 \text{ N}\cdot\text{m} = [8.851 \text{ lbf}\cdot\text{in}]$$

$$1 \text{ N} = [0.2248 \text{ lbf}]$$

$$1 \text{ mm} = [0.0394 \text{ in}]$$

$$1 \text{ cm}^3 = [0.061 \text{ in}^3]$$

$$1 \text{ l} = [0.264 \text{ US gal}]$$

$$1 \text{ bar} = [14.5 \text{ psi}]$$

$$^{\circ}\text{F} = [1.8^{\circ}\text{C} + 32]$$

Survey of literature with technical data on Danfoss Steering Components

Detailed data on all Danfoss steering components and accessories can be found in our steering component catalogues, which is divided in to the following individual sub catalogues:

General information	Steering components
Technical data on mini steering units	OSPM
Technical data on open center, and closed center steering units	OSPB, OSPC, and OSPD
Technical data on load sensing steering units, priority valves and flow amplifiers	OSPB, OSPC, OSPF, OSPD, OSPL, OSPBX, OSPLX, OVPL, OLS and OSQ
Technical data on hydraulic and electrohydraulic pilot operated steering valves, electrical actuation modules and appropriate steering units.	EHPS, EHPS w. OLS 320, PVE for EHPS and OSPCX
Technical data on combined steering unit/electrohydraulic steering valves and steering wheel sensors	OSPE
	SASA
Technical data on load sensing steering unit with amplification	OSPU

For technical information on individual variants, please contact the Danfoss Sales Organization.

Steering unit OSPM

General

Introduction

Danfoss has marketed mini-steering unit OSPM and the matching steering column OTPM ever since 1995. Positive feedback from the market drives the development and many upratings were introduced to the OSPM-program in the last years. Among these are:

- Introduction of side-ported OSPM versions with 4 and 5 ports in open center non reaction and power beyond variants.
- Introduction of OSPM in a load sensing version. Now available in all standard displacements with valve functions including LS check valve and pilot relief.
- Availability of new neural setting spring packs for optimized steering feel.
- Additional displacements introduced. E.g. new 70 cm³ [4.27 in³] gearset variant plus supplementary valve functions.
- Improved machining process for extra low operational noise level on all OSPM variants.

Application

Examples:

- Minitractors
- Turfcare machines
- Universal tractors
- Forklift trucks
- Municipal vehicles
- ATV's

Advantages

- Small dimensions and low weight
- End ports with integrated fittings
- Easy installation and accessibility
- Possibility of integrated steering column
- Low pressure drop
- Low input torque
- Low system price
- Low noise

Function

OSPM is a hydrostatic steering unit which can be used with an add-on steering column, OTPM/OTPM-T or with the steering column integrated with the unit.

The steering unit consists of a rotary valve and a rotary meter.

Via a steering column or directly the steering unit is connected to the steering wheel of the vehicle. When the steering wheel is turned, oil is directed from the steering system pump via the rotary valve and rotary meter to the cylinder ports L or R, depending on the direction of turn. The rotary meter meters the oil flow to the steering cylinder in proportion to the angular rotation of the steering wheel.

If the oil supply from the steering system pump fails or is too small, the steering unit is able to work as a manual steering pump.

Versions

The mini-steering unit is available in three versions:

- Open-Center Non-Reaction (ON) version, and

Steering unit OSPM

- Power Beyond (PB) version where surplus oil can be led to the working hydraulics, and
- Load Sensing (LS) dynamic versions.

OSPM ON

Open centre steering units have open connection between pump and tank in the neutral position.

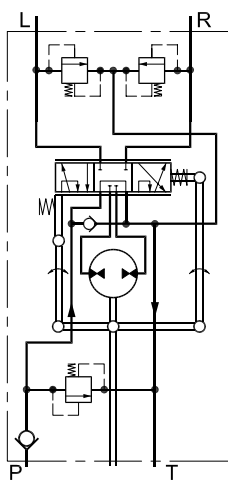
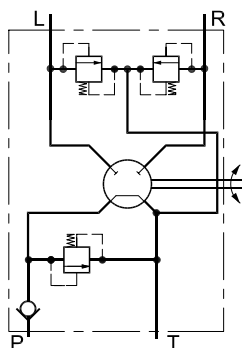

150-539,11

Steering unit OSPM

OSPM PB

In Power Beyond steering units the oil from the pump is routed in the neutral position through the steering unit to the E-port.

The steering function always has priority, with any excess oil flow passing through the E port.

If the steering wheel is held at full lock, all flow is led to tank across the pressure relief valve, and flow from the E port will stop.

OSPM PB

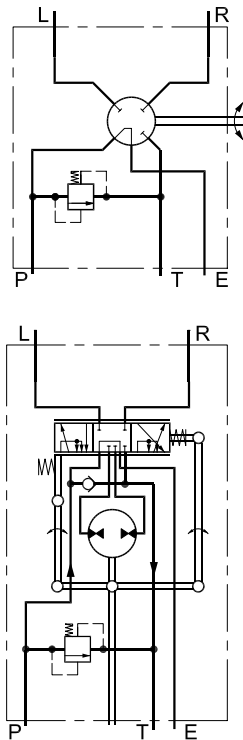

150-540.11

Steering unit OSPM

OSPM LS

In load sensing steering systems both the steering system and the working hydraulics can be supplied with oil from the same pump. The load sensing steering unit works in line with a priority valve and can be connected in parallel with working hydraulics. The priority valve ensures that the steering unit always has priority of supply from the pump before any working hydraulics. Steering input is signalled back to the priority valve and/or a load sense pump through an extra port on the steering unit. The load sense signal controls the oil flow from the priority valve (and/or LS pump). When the steering wheel is in neutral full flow is available for the working hydraulics connected to the excess flow port of the priority valve. All OSPM LS steering units are dynamic type.

OSPM LS

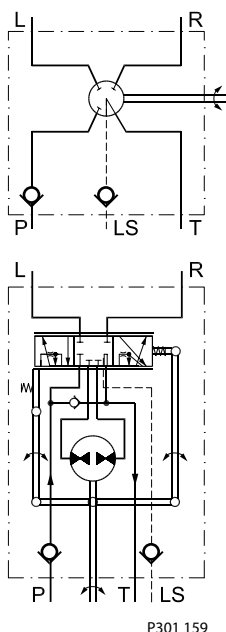

P301 159

Code numbers

The mini-steering unit is available with displacements of 32, 50, 63, 70, 80 and 100 cm³/rev. [1.95, 3.05, 3.84, 4.27, 4.88 and 6.10 in³/rev.] The check valve for emergency steering is standard in all versions, but optionally, the OSPM can also be fitted with an integrated relief valve and/or a shock valve. Check valve in P port is optional in OSPM rear port versions. Check valve in LS port is standard in all LS versions.

The OSPM is also available with an integrated steering column or alternatively in a version prepared for a flange-on steering column (see page 21).

The connections are integrated endport fittings of the ORFS-type (O-ring face seal). See [Port Connections](#). Standard port size is 9/16"-18 UNF

OSPM open center non-reaction steering units

OSPM open center non-reaction (OSPM ON) code numbers

Steering unit	Code No. OSPM	Relief valve		Shock valves		Check valve in P-port	Steering wheel connection	Weight	
		bar	[psi]	bar	[psi]			kg	[lb]
OSPM 32 ON	150L0101	None		None		None	Flanged-on	2.3	[5.1]
OSPM 32 ON	150L2102	None		None		None	Integrated type A	2.3	[5.1]

Steering unit OSPM

OSPM open center non-reaction (OSPM ON) code numbers (continued)

Steering unit	Code No. OSPM	Relief valve		Shock valves		Check valve in P-port	Steering wheel connection	Weight	
		bar	[psi]	bar	[psi]			kg	[lb]
OSPM 32 ON	150L2103	75-80	[1087-1160]	None		None	Flanged-on	2.3	[5.1]
OSPM 32 ON	150L2104	75-80	[1087-1160]	None		None	Integrated type A	2.3	[5.1]
OSPM 40 ON	150L2079	75-80	[1087-1160]	None		None	Flanged-on	2.4	[5.3]
OSPM 50 ON	150L0111	None		None		None	Flanged-on	2.5	[5.5]
OSPM 50 ON	150L0112	None		None		None	Integrated type A	2.5	[5.5]
OSPM 50 ON	150L0133	None		None		None	Integrated type B	2.5	[5.5]
OSPM 50 ON	150L2113	75-80	[1087-1160]	None		None	Flanged-on	2.5	[5.5]
OSPM 50 ON	150L2114	75-80	[1087-1160]	None		None	Integrated type A	2.5	[5.5]
OSPM 50 ON	150L2150	90-95	[1305-1378]	150-170	[2175-2465]	Yes	Integrated type A	2.5	[5.5]
OSPM 50 ON	150L2132	75-80	[1087-1160]	None		None	Integrated type B	2.5	[5.5]
OSPM 63 ON	150L0142	75-80	[1087-1160]	None		None	Flanged-on	2.6	[5.7]
OSPM 63 ON	150L0143	75-80	[1087-1160]	None		None	Integrated type A	2.6	[5.7]
OSPM 63 ON	150L0144	75-80	[1087-1160]	None		None	Integrated type B	2.6	[5.7]
OSPM 80 ON	150L0121	None		None		None	Flanged-on	2.7	[5.9]
OSPM 80 ON	150L0122	None		None		None	Integrated type A	2.7	[5.9]
OSPM 80 ON	150L0137	None		None		None	Integrated type B	2.7	[5.9]
OSPM 80 ON	150L2123	75-80	[1087-1160]	None		None	Flanged-on	2.7	[5.9]
OSPM 80 ON	150L2124	75-80	[1087-1160]	None		None	Integrated type A	2.7	[5.9]
OSPM 80 ON	150L2136	75-80	[1087-1160]	None		None	Integrated type B	2.7	[5.9]
OSPM 100 ON	150L0154	75-80	[1087-1160]	None		None	Flanged-on	2.9	[6.4]
OSPM 100 ON	150L0155	75-80	[1087-1160]	None		None	Integrated type A	2.9	[6.4]
OSPM 100 ON	150L0156	75-80	[1087-1160]	None		None	Integrated type B	2.9	[6.4]

OSPM power beyond steering units

OSPM power beyond (OSPM PB) code numbers

Steering unit	Code No. OSPM	Relief valve		Shock valves		Check valve in P-port	Steering wheel connection	Weight	
		bar	[psi]	bar	[psi]			kg	[lb]
OSPM 32 PB	150L0105	None		None		None	Flanged-on	2.6	[5.7]
OSPM 32 PB	150L2106	None		None		None	Integrated type A	2.6	[5.7]
OSPM 32 PB	150L0107	75-80	[1087-1160]	None		None	Flanged-on	2.6	[5.7]
OSPM 32 PB	150L2108	75-80	[1087-1160]	None		None	Integrated type A	2.6	[5.7]
OSPM 50 PB	150L0115	None		None		None	Flanged-on	2.8	[6.2]
OSPM 50 PB	150L0116	None		None		None	Integrated type A	2.8	[6.2]
OSPM 50 PB	150L0135	None		None		None	Integrated type B	2.8	[6.2]
OSPM 50 PB	150L2117	75-80	[1087-1160]	None		None	Flanged-on	2.8	[6.2]
OSPM 50 PB	150L2118	90-95	[1305-1378]	None		None	Integrated type A	2.8	[6.2]
OSPM 50 PB	150L0134	75-80	[1087-1160]	None		None	Integrated type B	2.8	[6.2]
OSPM 63 PB	150L0163	75-80	[1087-1160]	None		None	Flanged-on	2.9	[6.4]
OSPM 63 PB	150L0164	75-80	[1087-1160]	None		None	Integrated type A	2.9	[6.4]
OSPM 63 PB	150L0165	75-80	[1087-1160]	None		None	Integrated type B	2.9	[6.4]

Steering unit OSPM

OSPM power beyond (OSPM PB) code numbers (continued)

Steering unit	Code No. OSPM	Relief valve		Shock valves		Check valve in P-port	Steering wheel connection	Weight	
		bar	[psi]	bar	[psi]			kg	[lb]
OSPM 80 PB	150L0125	None		None		None	Flanged-on	3.0	[6.6]
OSPM 80 PB	150L0126	None		None		None	Integrated type A	3.0]	[6.6]
OSPM 80 PB	150L0139	None		None		None	Integrated type B	3.0	[6.6]
OSPM 80 PB	150L0127	75-80	[1087-1160]	None		None	Flanged-on	3.0	[6.6]
OSPM 80 PB	150L2128	75-80	[1087-1160]	None		None	Integrated type A	3.0	[6.6]
OSPM 80 PB	150L0138	75-80	[1087-1160]	None		None	Integrated type B	3.0	[6.6]
OSPM 100 PB	150L0160	75-80	[1087-1160]	None		None	Flanged-on	3.2	[7.1]
OSPM 100 PB	150L0161	75-80	[1087-1160]	None		None	Integrated type A	3.2	[7.1]
OSPM 100 PB	150L0162	75-80	[1087-1160]	None		None	Integrated type B	3.2	[7.1]

If you wish other valve combinations or valve settings please fill in the order form on page 11 and contact the Danfoss Sales Organisation.

OSPM load sensing steering units

OSPM load sensing (OSPM LS) code numbers

Steering unit	Code No.	Relief valve		Shock valves		Check valve in P-port	Check valve in LS-Port	Steering wheel connection	Weight	
		bar	[psi]	bar	[psi]				kg	[lb]
OSPM 63 LS	11059674	75-80	[1087-1160]	None		Yes	Yes	Flanged-on	2.9	[6.4]
OSPM 63 LS	11059675	75-80	[1087-1160]	None		Yes	Yes	Integrated type A	2.9	[6.4]
OSPM 63 LS	11059676	75-80	[1087-1160]	None		Yes	Yes	Integrated type B	2.9	[6.4]
OSPM 80 LS	11059680	75-80	[1087-1160]	None		Yes	Yes	Flanged-on	3.0	[6.6]
OSPM 80 LS	11059681	75-80	[1087-1160]	None		Yes	Yes	Integrated type A	3.0	[6.6]
OSPM 80 LS	11059682	75-80	[1087-1160]	None		Yes	Yes	Integrated type B	3.0	[6.6]
OSPM 100 LS	11059683	75-80	[1087-1160]	None		Yes	Yes	Flanged-on	3.2	[7.1]
OSPM 100 LS	11059684	75-80	[1087-1160]	None		Yes	Yes	Integrated type A	3.2]	[7.1]
OSPM 100 LS	11059685	75-80	[1087-1160]	None		Yes	Yes	Integrated type B	3.2	[7.1]

If you wish other valve combinations or valve settings, please fill in the order below and contact the Danfoss Sales Organisation.

OSPMS sideported steering units

OSPMS sideported (OSPM S ON) code numbers

Steering unit	Code No.	Relief valve		Shock valves		Check valve in P-port	Check valve in LS-Port	Steering wheel connection	Weight	
		bar	[psi]	bar	[psi]				kg	[lb]
OSPM S 63 ON	11059686	75-80	[1087-1160]	None		None	Yes	Flanged-on	2.8	[6.2]
OSPM S 100 ON	11059689	75-80	[1087-1160]	None		None	Yes	Flanged-on	3.1	[6.8]
OSPM S 63 PB	11059690	75-80	[1087-1160]	None		None	Yes	Flanged-on	3.2	[7.1]
OSPM S 100 PB	11059693	75-80	[1087-1160]	None		None	Yes	Flanged-on	3.5	[7.7]

Steering unit OSPM

Order specification

Specification table none catalogue for numbers of OSPM steering units

Your company	Name	Vehicle			Potential, pcs/year		Completed by	Date
Steering unit type	OSPM ON	OSPM PB			OSPM LS			
DP ¹⁾ cm ³ /rev [in ³ /rev] OSPM	32 [1.95]	40 [2.44]	50 [3.05]	60 [3.84]	70 [4.27]	80 [4.88]	100 [6.10]	
Rear ports P, T, E/LS	9/16"-18 UNF ORFS			11/16"-16 UNF ORFS		G 1/4"-30 flare		
Rear Ports L, R	9/16"-18 UNF ORFS			11/16"-16 UNF ORFS		G 1/4"-30 flare		
Side ports P, T, E/LS	9/16"-18 UNF			11/16"-16 UNF		M 14 x 1.5		
Side ports L,R	9/16"-18 UNF			11/16"-16 UNF		M 14 x 1.5		
RV ²⁾ bar [psi]	75 [1087]	80 [1160]	90 [1305]	100 [1450]	110 [1595]	125 [1812]	140 [2030]	No relief
Shock valves bar [psi]	130 [1885]	140 [2030]	150 [2175]	160 [2320]	170 [2610]	185 [2683]	200 [2900]	No shock valves
Check valve in P-line	YES				NO			

¹⁾ Displacement

²⁾ Pressure relief valve

An alternative way to specify a variant is to state an existing code number and add the modifications you would like to have in the basic steering unit.

Code number of basic steering unit: _____

Requested modifications: _____

Technical data

Common data

Look in sub catalogue: "General Steering Components"

Steering unit OSPM

Displacement, flow and pressure OSPM ON/PB

Steering unit	Displacement		Recommended* oil flow		Max pressure on connections									
					P		T		L, R		E			
	cm ³ /rev	[in ³ /rev]	l/min	[US gal/min]	bar	[psi]	bar	[psi]	bar	[psi]	bar	[psi]		
OSPM 32 ON	32	[1.95]	3-9	[0.8-2.4]	140	[2030]	20	[290]	200	[2900]	-			
OSPM 40 ON	40	[2.44]	4-12	[1.1-3.2]										
OSPM 50 ON	50	[3.05]	5-15	[1.3-4.0]										
OSPM 63 ON	63	[3.84]	6-18	[1.6-4.8]										
OSPM 70 ON	70	[4.27]	7-20	[1.9-5.3]										
OSPM 80 ON	80	[4.88]	7-20	[1.9-5.3]										
OSPM 100 ON	100	[6.10]	7-20	[1.9-5.3]										
OSPM 32 PB	32	[1.95]	3-20	[0.8-5.3]							140		[2030]	
OSPM 40 PB	40	[2.44]	4-20	[1.1-5.3]										
OSPM 50 PB	50	[3.05]	5-20	[1.3-5.3]										
OSPM 63 PB	63	[3.84]	6-20	[1.6-5.3]										
OSPM 70 PB	70	[4.27]	7-20	[1.9-5.3]										
OSPM 80 PB	80	[4.88]	7-20	[1.9-5.3]										
OSPM 100 PB	100	[6.10]	7-20	[1.9-5.3]										

* Criteria for determining the recommended oil flow:

- Must minimum be the oil flow it takes to ensure sufficient steering speed at idle motor speed
- Must ensure the least possible pressure loss at full speed

The steering unit can cope with an oil flow that is up to 50% higher than the maximum recommended value.

Displacement, flow and pressure OSPM LS

Steering unit	Displacement		Rated oil flow*		Max pressure on connections							
					P		T		L, R		LS	
	cm ³ /rev	[in ³ /rev]	l/min	[US gal/min]	bar	[psi]	bar	[psi]	bar	[psi]	bar	[psi]
OSPM 32 LS	32	[1.95]	3	[0.79]	140	[2030]	20	[290]	200	[2900]	140	[2030]
OSPM 40 LS	40	[2.44]	4	[1.06]								
OSPM 50 LS	50	[3.05]	5	[1.32]								
OSPM 63 LS	63	[3.84]	6	[1.58]								
OSPM 70 LS	70	[4.27]	7	[1.85]								
OSPM 80 LS	80	[4.88]	8	[2.11]								
OSPM 100 LS	100	[6.10]	10	[2.64]								

* Criteria for determining the recommended oil flow:

- Must minimum be the oil flow it takes to ensure sufficient steering speed at idle motor speed
- Must ensure the least possible pressure loss at full speed

The steering unit can cope with an oil flow that is up to 50% higher than the maximum recommended value.

Manual steering pressure

Under normal operating where the steering pump supplies an adequate oil flow at the required pressure, the maximum torque on the steering wheel will not exceed 2 Nm [17.7 lbf-in]. If the oil flow from the steering system pump fails or is too small, the steering unit functions automatically as a manual steering pump.

Manual steering can only be used for a limited control of the vehicle if a sudden drop of pump pressure occurs.

Steering unit OSPM

The table below shows the manual steering pressure (P_m) for all sizes of Danfoss steering units type OSPM at a steering wheel torque of 80 N·m [708 lbf·in].

The values apply only if the suction conditions on the steering unit T port are adequate.

OSPM		32	40	50	63	80	100
P_m	bar	100	90	80	60	50	40
	[psi]	[1450]	[1305]	[1160]	[870]	[725]	[580]

Valve function in OSPM steering units

The data below comes from measurements on a representative sample of steering unit from production. Oil with a viscosity of 21 mm²/s [100 SUS] at 50°C [122°F] was used during measuring.

Pressure relief valve

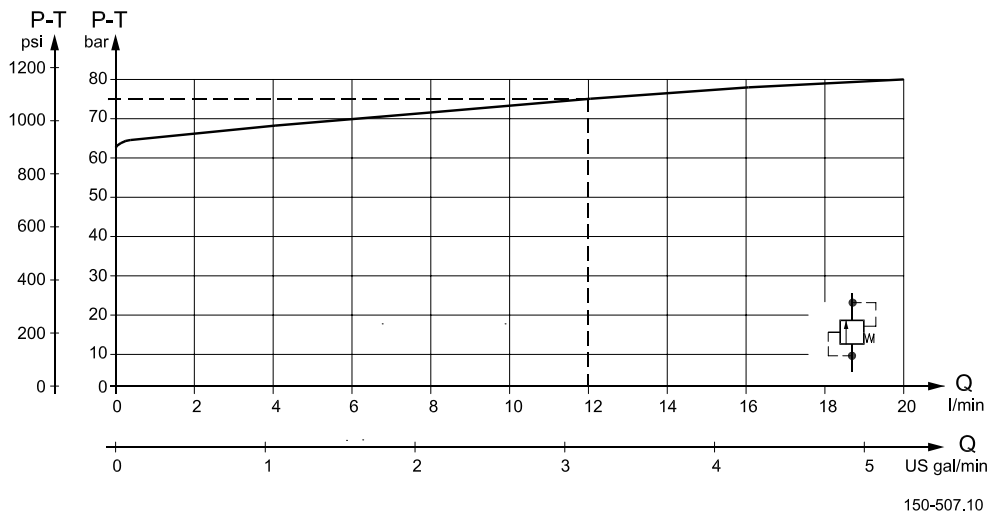

The pressure relief valve protects the pump and steering unit against excess pressure and limits the system pressure while steering.

The pressure relief valve in the steering unit will limit the maximum pressure drop from P to T.

The pressure relief valve is set at 12 l/min [3.17 US gal/min] flow.

Steering unit OSPM

Pilot pressure relief valve

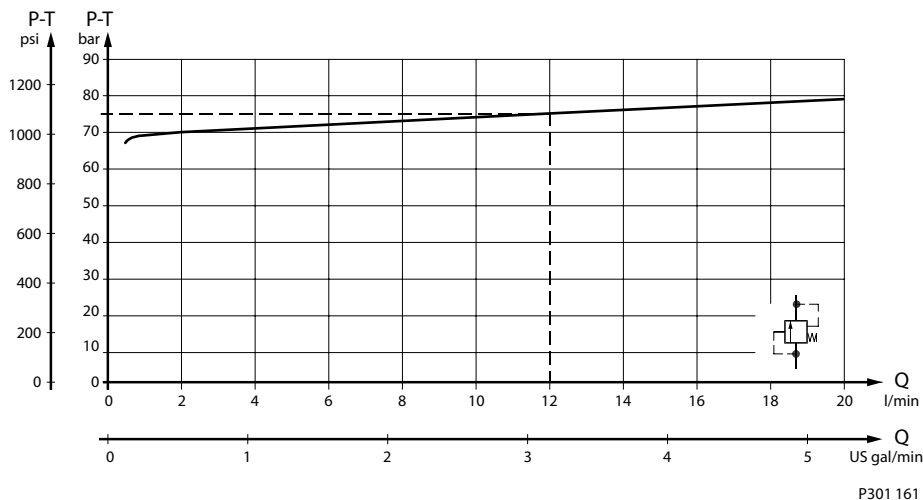

The pilot pressure relief valve together with the priority valve limits the maximum steering pressure P-T. The pilot pressure relief valve is set at an oil flow to the priority valve of 12 l/min [3.17 US gal/min]. For the OSPM LS load sensing dynamic steering units, the setting values are valid at a dynamic flow of 0.6 l/min [0.16 US gal/min].

Shock valves

The shock valves protect the steering unit against shocks from external forces on the steering cylinder. The shock valves in the steering unit limit the max pressure drop from L to T and from R to T. The shock valves are set at 1 l/min [0.27 US gal/min].

They are of the direct type and therefore have a very quick reaction. The setting tolerance is +20 bar [+290 psi].

Check valve

The check valve protects the driver against kickbacks in the steering wheel. It prevents the oil from flowing back into the pump line during steering under high pressure on the cylinder side. The check valve is mounted in the P-connection of the steering unit.

Pressure drop in neutral

The pressure drop is measured with the steering unit in neutral position.

On the OSPM ON the pressure drop is measured from P to T.

On the OSPM PB the pressure drop is measured from P to E.

The following values are valid at an oil temperature of 50 °C [122 °F] for rear ported units and at a viscosity of 21 mm²/S [100 SUS]

Steering unit OSPM

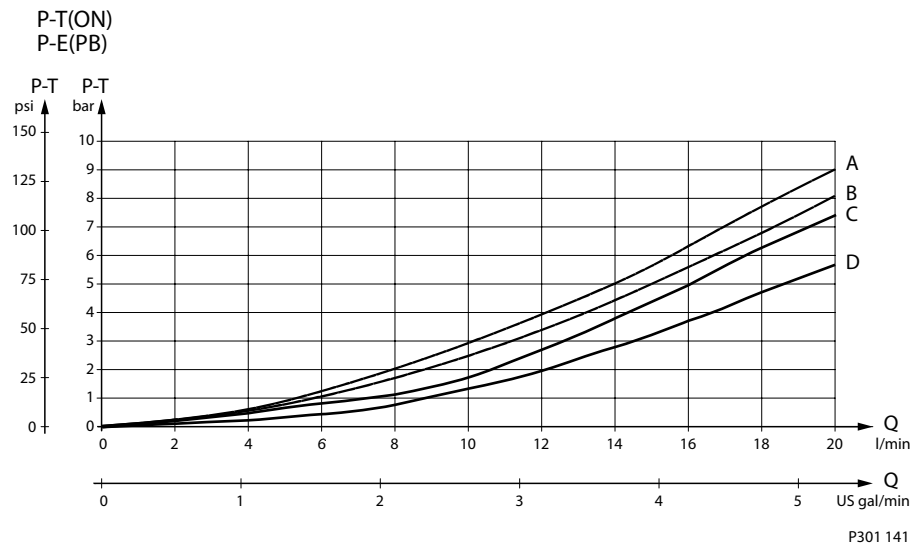

- A:** OSPM 32 ON + all PB
- B:** OSPM 50-100 ON
- C:** OSPMS PB
- D:** OSPMS ON

Port connections

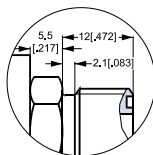

150-480,10

The connections of all rear ported OSPM-steering units in the catalogue are 9/16-18 UNF of the O-ring face seal type (ORFS).

The integrated end port fittings are specially developed for OSPM and therefore easily interchangeable.

Dimensions of O-rings for 9/16-18 UNF ORFS ports: 7.65 × 1.78 mm [3.02 × 0.702 in] (SAE J515 seal size no. 011).

Set of seals Danfoss code no. 150L4042 contains 5 pcs. of these O-rings.

The standard port size for all sideported OSPM versions in this catalogue is 9/16-18 UNF

Units are also available with M 14 × 1.5 : ISO 6149-1

Steering unit OSPM

Dimensions

OSPM dimensions

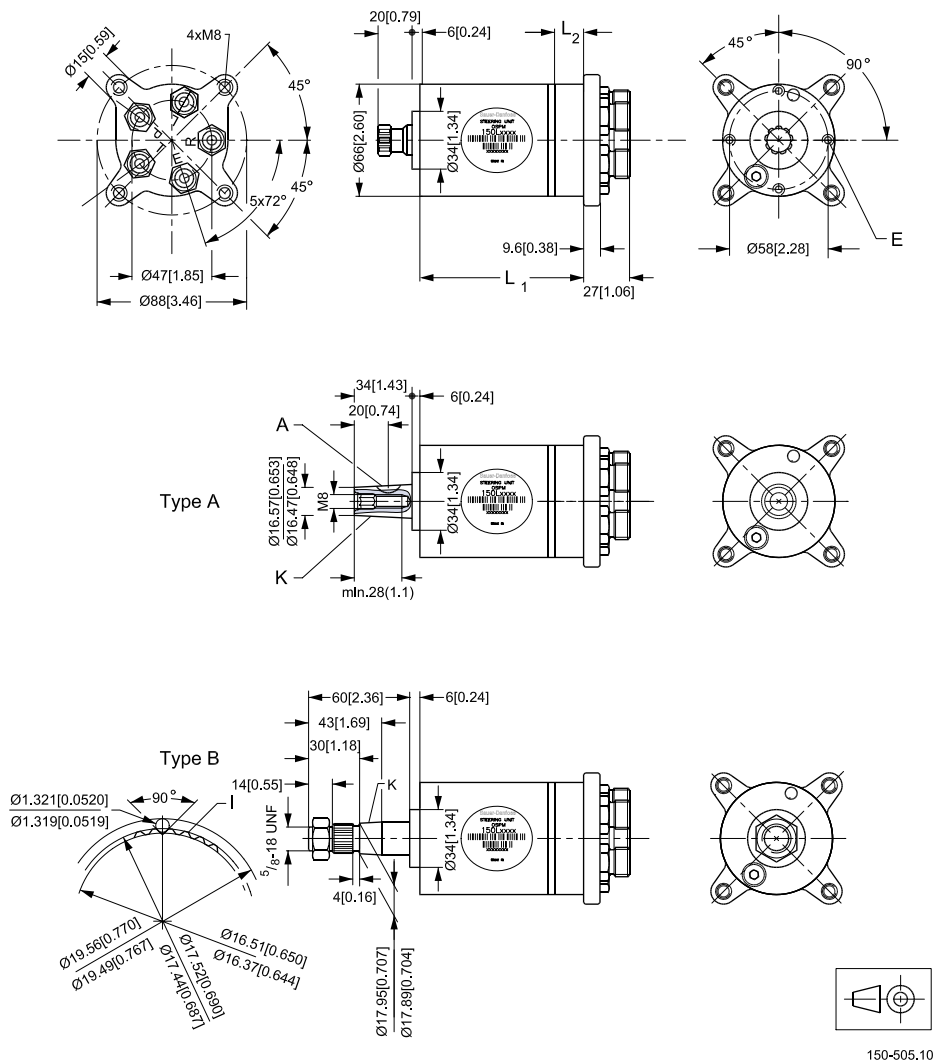

E: 4 × M6, 11 mm [0.432 in] deep

A: 5 × 6.5 DIN 6888
 (Not included)

K: Taper 1:20
 With 1 1/16 in-40 serrations
 dmin = 17.92 mm [0.72 in]

K: Taper 1:12

Steering unit OSPM

Mini steering unit	L ₁		L ₂	
	mm	[in]	mm	[in]
OSPM 32 ON	90	[3.54]	11.0	[0.43]
OSPM 40 ON	93	[3.66]	13.7	[0.54]
OSPM 50 ON	96	[3.78]	17.1	[0.67]
OSPM 63 ON	100	[3.94]	21.6	[0.85]
OSPM 70 ON	103	[4.05]	24.0	[0.94]
OSPM 80 ON	106	[4.17]	27.4	[1.08]
OSPM 100 ON	113	[4.45]	34.2	[1.35]
OSPM 32 PB/LS	103	[4.06]	11.0	[0.43]
OSPM 50 PB/LS	109	[4.29]	17.1	[0.67]
OSPM 63 PB/LS	113	[4.45]	21.6	[0.85]
OSPM 70 PB/LS	116	[4.57]	24.0	[0.94]
OSPM 80 PB/LS	119	[4.69]	27.4	[1.08]
OSPM 100 PB/LS	126	[4.96]	34.2	[1.35]

Steering unit OSPM

OSPMS dimensions

E: 4xM6.11mm [0.432 in] deep

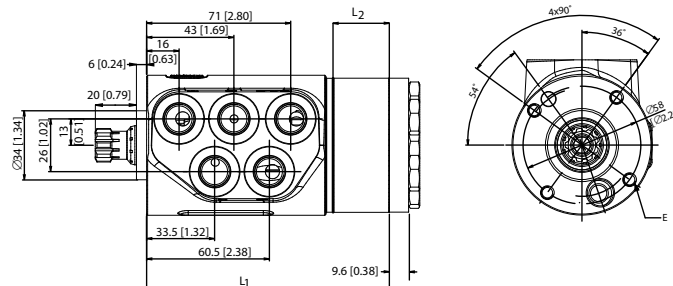

Type A

A: 5x6.5 DIN 6888
 K: Taper 1:20

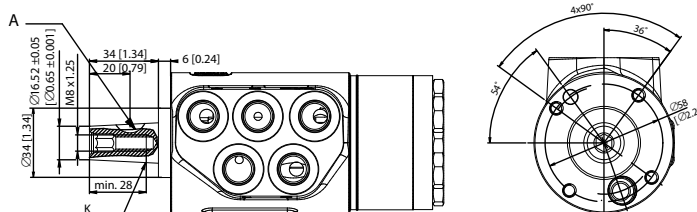

Type B

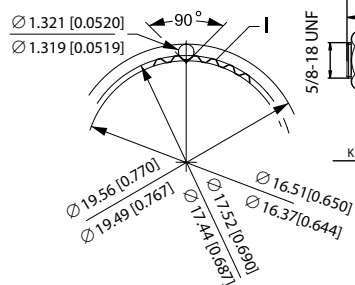

With 1 1/16 in-40 serrations
 dmin = 17.92 mm [0.72 in]

K: Taper 1:12

P301 150

Steering unit OSPM

OSPMS sideported versions available

Mini steering unit	L ₁		L ₂	
	mm	[in]	mm	[in]
OSPMS 63 ON	100	[3.94]	21.6	[0.85]
OSPMS 80 ON	106	[4.17]	27.4	[1.08]
OSPMS 100 ON	113	[4.45]	34.2	[1.35]
OSPMS 63 PB	113	[4.45]	21.6	[0.85]
OSPMS 80 PB	119	[4.69]	27.4	[1.08]
OSPMS 100 PB	126	[4.96]	34.2	[1.35]

Steering column for OSPM

Load on integrated steering column

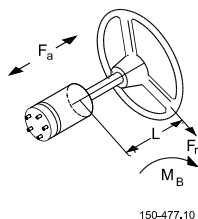

Symbols:

L (m/in): Axial length between OSPM housing and steering wheel

F_r (N/lb): Radial force on steering wheel

F_a (N/lb): Axial force on steering wheel

M_B (Nm/lbf-in): Bending moment on steering column $M_B = F_r \cdot L$

The following max. permissible values must not be exceeded:

M_B max.: 50 Nm [438 lbf-in]

F_r max: 500 N [112 lb]

F_a max: 600 N [135 lb]

With a given length L the max. force F_r on the steering wheel can be calculated:

$F_r = M_B \text{ max N; } L \text{ in m}$

$L + 0.015$

$F_r = M_B \text{ max lb; } L \text{ in inch}$

$L + 0.590$

Load on the steering unit column

The construction of the steering column must ensure that no axial or radial forces are transferred to the steering unit.

Such forces may prevent the steering unit from returning to neutral position automatically after a steering action has been completed.

Installing the steering column

Maximum tightening torque for fixing screws: 10^{+3}_{-0} N·m [88^{+27}_{-0} lbf·in]

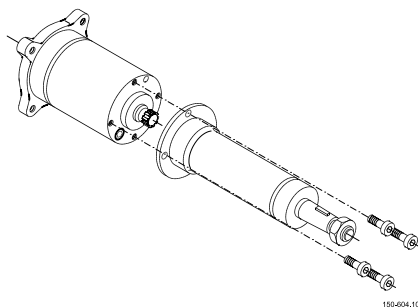

Products we offer:

- Bent Axis Motors
- Closed Circuit Axial Piston Pumps and Motors
- Displays
- Electrohydraulic Power Steering
- Electrohydraulics
- Hydraulic Power Steering
- Integrated Systems
- Joysticks and Control Handles
- Microcontrollers and Software
- Open Circuit Axial Piston Pumps
- Orbital Motors
- PLUS+1® GUIDE
- Proportional Valves
- Sensors
- Steering
- Transit Mixer Drives

Danfoss Power Solutions is a global manufacturer and supplier of high-quality hydraulic and electronic components. We specialize in providing state-of-the-art technology and solutions that excel in the harsh operating conditions of the mobile off-highway market. Building on our extensive applications expertise, we work closely with our customers to ensure exceptional performance for a broad range of off-highway vehicles.

We help OEMs around the world speed up system development, reduce costs and bring vehicles to market faster.

Danfoss – Your Strongest Partner in Mobile Hydraulics.

Go to www.powersolutions.danfoss.com for further product information.

Wherever off-highway vehicles are at work, so is Danfoss. We offer expert worldwide support for our customers, ensuring the best possible solutions for outstanding performance. And with an extensive network of Global Service Partners, we also provide comprehensive global service for all of our components.

Please contact the Danfoss Power Solution representative nearest you.

Comatrol

www.comatrol.com

Schwarzmueller-Inverter

www.schwarzmueller-inverter.com

Turolla

www.turollaocg.com

Hydro-Gear

www.hydro-gear.com

Daikin-Sauer-Danfoss

www.daikin-sauer-danfoss.com

Local address:

Danfoss Power Solutions (US) Company
2800 East 13th Street
Ames, IA 50010, USA
Phone: +1 515 239 6000

Danfoss Power Solutions GmbH & Co. OHG
Krokamp 35
D-24539 Neumünster, Germany
Phone: +49 4321 871 0

Danfoss Power Solutions ApS
Nordborgvej 81
DK-6430 Nordborg, Denmark
Phone: +45 7488 2222

Danfoss Power Solutions Trading (Shanghai) Co., Ltd.
Building #22, No. 1000 Jin Hai Rd
Jin Qiao, Pudong New District
Shanghai, China 201206
Phone: +86 21 3418 5200

Danfoss can accept no responsibility for possible errors in catalogues, brochures and other printed material. Danfoss reserves the right to alter its products without notice. This also applies to products already on order provided that such alterations can be made without changes being necessary in specifications already agreed. All trademarks in this material are property of the respective companies. Danfoss and the Danfoss logotype are trademarks of Danfoss A/S. All rights reserved.