

ENGINEERING
TOMORROW



Technical Information

Proportional Valve Group PVG 32



Revision history

Table of revisions

Date	Changed	Rev
November 2017	Dimenions section changes.	0803
August 2017	Added informational note to Technical Data section.	0802
March 2016	Pressure-compensated PVB, open center PVP; Characteristics for float position main spools.	0801
March 2016	Updated for Engineering Tomorrow design.	0710
August 2015	PVPX modules description updated	0709
February 2006 - Aug 2015	Various changes	BA - HH
January 2005	New Edition	AA

Contents

PVG general description

Features of PVG 32.....	5
PVG modules	6
PVP, pump side modules overview.....	6
PVB, basic modules.....	6
Actuation modules.....	6
Remote control units	7
Open center PVP.....	8
Closed center PVP.....	8
Sectional view.....	9
Load sensing for variable displacement pump supply.....	10

Safety in application

Example of a control system for manlift.....	12
Examples of wiring block diagram.....	14

Function

Load sensing controls.....	16
LS control with bleed orifice (do not use with PVG valves).....	16
Integral PC function.....	16
Load sensing system characteristics:.....	16
Remote pressure compensated controls.....	17
Remote pressure compensated system characteristics:.....	17
Typical applications for remote pressure compensated systems:.....	17
PVPC with check valve for open center PVP.....	17
PVPC without check valve for open or closed center PVP.....	19
PVMR, friction detent.....	20
PVMF, mechanical float position lock.....	20
PVBS, main spools for flow control (standard).....	20
PVBS, main spools for flow control (linear characteristic).....	21
PVBS, main spools with pressure compensated control.....	22
Pressure compensated system characteristics.....	22
Typical applications for pressure compensated systems.....	22
PVBS, main spools for pressure control.....	23
Background.....	23
PVG 32 Principle.....	23
Pressure controlled spool application.....	24
Sizing.....	25
Limitation.....	25
PVPX, electrical LS unloading valve.....	26

PVG 32 Technical Data

PVM operating force.....	28
PVH, hydraulic actuation.....	28
PVE actuation literature reference.....	28

Technical characteristics

PVP pressure relief valve characteristics.....	29
PVB, basic modules oil flow characteristics.....	30
Pressure-compensated PVB, open center PVP	31
PVB without pressure compensation, open center PVP.....	32
PVB without pressure compensation, closed center PVP.....	34
PVLP, shock and PVLA, suction valves.....	36
Pressure control spool flow characteristics.....	36
Pressure build-up for pressure controlled spools.....	38
Examples of how to use the characteristics for pressure control spools.....	38
Characteristics for float position main spools.....	39

Hydraulic systems

Manually actuated PVG 32 – fixed displ. pump.....	41
Electrically actuated PVG 32 – variable displ. pump.....	42

Contents

Fluid Specifications

Oil.....	43
Mineral oil.....	43
Non-flammable fluids.....	43
Filtration.....	43

Dimensions and ports description

PVM, control lever positions.....	46
Surface treatment.....	46

Parts description and code numbers

PVP schematics and code numbers.....	47
PVB, basic module code numbers.....	50
PVLA, suction valve (fitted in PVB).....	53
PVLP, shock and suction valve (fitted in PVB).....	53
PVM, PVMD, PVMR, and PVMF code numbers.....	54
PVH, hydraulic actuation code numbers.....	55
PVE actuation literature reference.....	55
PVS, end plate.....	55
PVAS, assembly kit code numbers.....	56
PVPX, electrical LS unloaded valve.....	56
PVPC, plug for external pilot oil supply.....	57
Standard FC spools.....	57
Standard FC spools, hydraulic actuation.....	59
FC spools for mechanical float position, PVMF.....	60
FC spools for friction detent, PVMR.....	60
FC spools with linear flow characteristic	61
Standard PC spools	61
Standard PC spools, hydraulic actuation.....	63

Order Specification

PVG 32 order specification.....	64
Reordering.....	64
Pressure setting limits.....	65
PVG 32 specification sheet.....	66
Standard and option assembly.....	66

PVG general description

PVG is a hydraulic, load-sensing proportional valve, designed for optimal machine performance and maximum design flexibility.

The PVG valve design is based on a modular concept that enables machine designers to specify a valve solution suitable for multiple market segments across multiple applications.

The load independent proportional control valve and high performance actuator technology combined with a low pressure drop design improves the machine performance and efficiency – increasing productivity and reducing energy consumption.

Features of PVG 32

- Load-independent flow control:
 - Oil flow to an individual function is independent of the load pressure of this function
 - Oil flow to one function is independent of the load pressure of other functions
- Reliable regulation characteristics across the entire flow range
- Load sense relief valves for A and B port enables reduced energy loss at target pressure
- Several options for connection threads and flange mount
- Compact design, easy installation and serviceability
- Energy-saving
- Up to 12 basic modules per valve group
- Low weight



PVG general description

PVG modules

PVP, pump side modules overview

- Built-in pressure relief valve
- Pressure gauge connection
- Versions:
 - Open center version for systems with fixed displacement pumps
 - Closed center version for systems with variable displacement pumps
 - Pilot oil supply for electrical actuator built into the pump side module
 - Pilot oil supply for hydraulic actuation built into the pump side module
 - Versions prepared for electrical LS unloading valve PVPX

PVB, basic modules

- Interchangeable spools
- Depending on requirements the basic module can be supplied with:
 - Integrated pressure compensator in channel P
 - Load holding check valve in channel P
 - Shock/suction valves for A and B ports
 - LS pressure limiting valves individually adjustable for ports A and B
 - Different interchangeable spool variants
 - All versions suitable for mechanical, hydraulic and electrical actuation

Actuation modules

The basic module is always fitted with mechanical actuator PVM and PVMD, which can be combined with the following as required:

- Electrical actuator (11 - 32 V ===):
 - PVES – proportional, Super
 - PVEH – proportional, High performance
 - PVEH-F – proportional high performance, Float
 - PVEA – proportional low hysteresis
 - PVEM – proportional, Medium performance
 - PVEO – ON/OFF
 - PVEH-U/PVES-U – proportional, voltage control, 0-10 V
 - PVED-CC – Digital CAN controlled J1939/ISOBUS
 - PVED-CX – Digital CAN controlled CANopen X-tra safety
 - PVEP – PWM voltage controlled (11-32 V)
 - PVHC – High Current actuator for PVG
- PVMR, cover for Mechanical detent
- PVMF, cover for Mechanical Float
- PVH, cover for Hydraulic actuation

PVG general description

Remote control units

- Electrical remote control units:
 - PVRE, PVRET
 - PVREL
 - PVRES
 - Prof 1
 - Prof 1 CIP
 - JS120
 - JS1000 Ball grip
 - JS1000 PRO grip
 - JS2000
 - JS6000
 - JS7000
- Hydraulic remote control unit: PVRHH

Electrical and hydraulic remote control units

PVRE, electrical control unit, 162F...

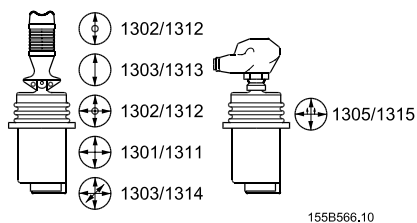

PVRH, hydraulic control unit, 155N...

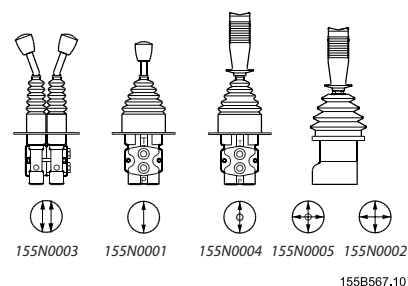

PVREL, electrical control unit, 155U...

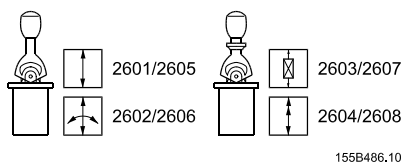

PVRES, electrical control unit, 155B...

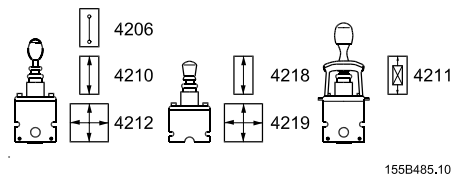

Prof 1, 162F...

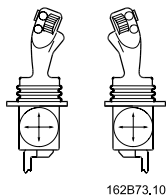

PVG general description

Open center PVP

Description of the example: PVG 32 with open center PVP (fixed displacement pump) and PVB with flow control spool.

When the pump is started and the main spools in the individual basic modules (**11**) are in the neutral position, oil flows from the pump, through connection P, across the pressure adjustment spool (**6**) to tank. The oil flow led across the pressure adjustment spool determines the pump pressure (stand-by pressure).

When one or more of the main spools are actuated, the highest load pressure is fed through the shuttle valve circuit (**10**) to the spring chamber behind the pressure adjustment spool (**6**), and completely or partially closes the connection to tank to maintain pump pressure. Pump pressure is applied to the right-hand side of the pressure adjustment spool.

The pressure relief valve (**1**) will open when the load pressure exceeds the set value, diverting pump flow back to tank.

In a pressure-compensated basic module the compensator (**14**) maintains a constant pressure drop across the main spool – both when the load changes and when a module with a higher load pressure is actuated.

With a non pressure-compensated basic module incorporating a load drop check valve (**18**) in channel P, the check valve prevents return oil flow.

The basic module can be supplied without the load drop check valve in channel P for functions with over-center valves.

The shock valves PVLP (**13**) with fixed setting and the suction valves PVLA (**17**) on ports A and B are used for the protection of the individual working function against overload and/or cavitation.

An adjustable LS pressure limiting valve (**12**) can be built into the A and B ports of pressure-compensated basic modules to limit the pressure from the individual working functions. The LS pressure limiting valves save energy compared with:

- PVLP all the oil flow to the working function will be led across the combined shock and suction valves to tank if the pressure exceeds the fixed setting.
- LS pressure limiting valves an oil flow of about 2 l/min [0.5 US gal/min] will be led across the LS pressure limiting valve to tank if the pressure exceeds the valve setting.

Please see the sectional drawing [Sectional view](#) on page 9 for better understanding of this example.

Closed center PVP

Description of the example: PVG 32 with closed center PVP (variable displacement pump) and PVB with flow control spool.

In the closed center version of PVP an orifice (**5**) and a plug (**7**) have been fitted instead of the plug (**4**). This means that the pressure adjustment spool (**6**) will open to tank when the pressure in channel P exceeds the set value of the pressure relief valve (**1**). The pressure relief valve in PVP should be set at a pressure of approx. 30 bar [435 psi] above maximum system pressure (set on the pump or external pressure relief valve).

In load sensing systems the load pressure is led to the pump control via the LS connection (**8**). In the neutral position the pump load sense control sets the displacement so that leakage in the system is compensated, to maintain the set stand-by pressure. When a main spool is actuated the pump load sense control will adjust the displacement so that the set differential pressure (margin) between P and LS is maintained.

Please see the sectional drawing [Sectional view](#) on page 9 for better understanding of this example.

PVG general description

Sectional view

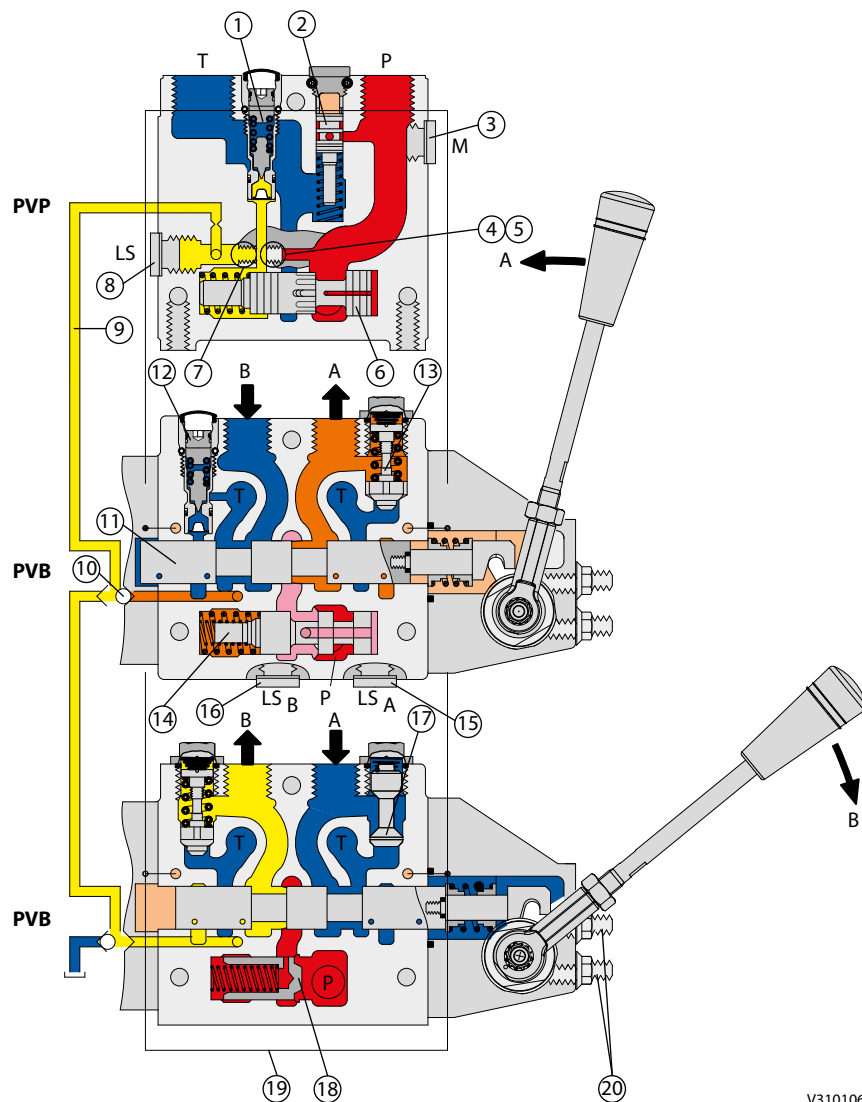

V310106.A

- | | |
|--|--|
| 1. Pressure relief valve | 11. Main spool |
| 2. Pressure reduction valve for pilot oil supply | 12. LS pressure limiting valve |
| 3. Pressure gauge connection | 13. Shock and suction valve, PVLP |
| 4. Plug, open center | 14. Pressure compensator |
| 5. Orifice, closed center | 15. LS connection, port A |
| 6. Pressure adjustment spool | 16. LS connection, port B |
| 7. Plug, closed center | 17. Suction valve, PVLA |
| 8. LS connection | 18. Load drop check valve |
| 9. LS signal | 19. Pilot oil supply for PVE |
| 10. Shuttle valve | 20. Maximum oil flow adjustment screws for A/B ports |

PVG general description

Load sensing for variable displacement pump supply

The pump receives fluid directly from the reservoir through the inlet line. A screen in the inlet line protects the pump from large contaminants.

The pump outlet feeds directional control valves such as PVG-32, hydraulic integrated circuits (HIC), and other types of control valves.

The PVG valve directs and controls pump flow to cylinders, motors and other work functions. A heat exchanger cools the fluid returning from the valve. A filter cleans the fluid before it returns to the reservoir.

Flow in the circuit determines the speed of the actuators. The position of the PVG valve spool determines the flow demand. A hydraulic pressure signal (LS signal) communicates demand to the pump control.

The pump control monitors the pressure differential between pump outlet and the LS signal, and regulates servo pressure to control the swashplate angle. Swashplate angle determines pump flow.

Actuator load determines system pressure. The pump control monitors system pressure and will decrease the swashplate angle to reduce flow if system pressure reaches the pump control setting.

A secondary system relief valve in the PVG valve acts as a back-up to control system pressure.

Pictorial circuit diagram

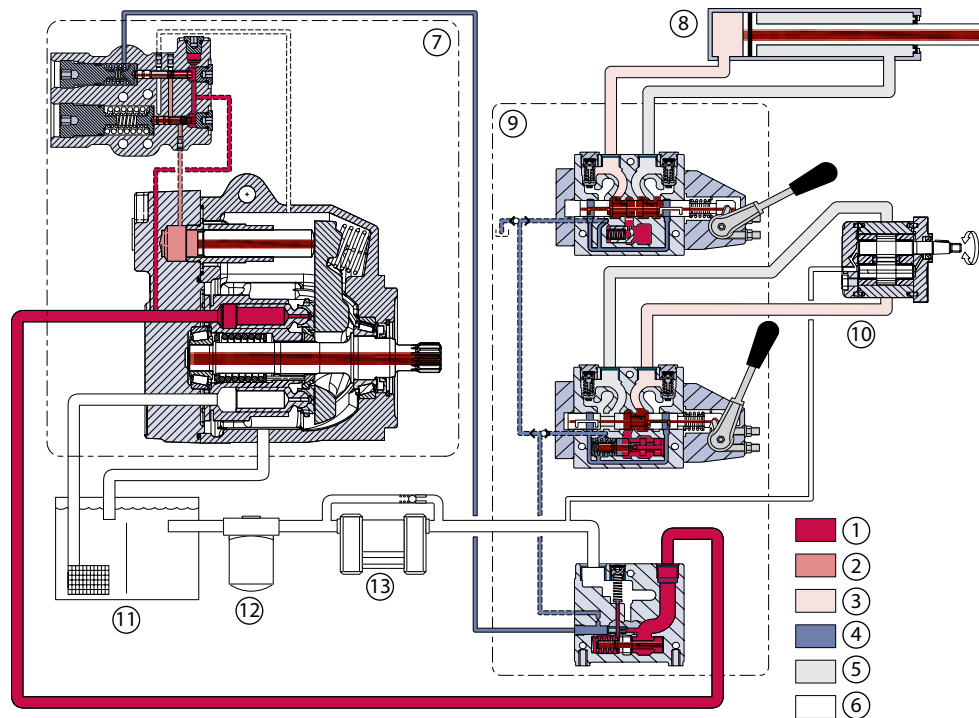

P101 658E

Safety in application

All types of control valves (incl. proportional valves) can fail, thus the necessary protection against the serious consequences of function failure should always be built into the system. For each application an assessment should be made for the consequences of pressure failure and uncontrolled or blocked movements. To determine the degree of protection that is required to be built into the application, system tools such as an FMEA (Failure Mode and Effect Analysis) and Hazard and Risk Analysis can be used.

FMEA – IEC EN 61508

FMEA (Failure Mode and Effect Analysis) is a tool used for analyzing potential risks. This analytical technique is utilized to define, identify, and prioritize the elimination or reduction of known and/or potential failures from a given system before it is released for production. Please refer to the standard IEC FMEA 61508.

Hazard and risk analysis ISO 12100-1/14121

This analysis is a tool used in new applications as it will indicate whether there are special safety considerations to be met according to the machine directives EN 13849. Dependent on the determined levels conformity this analysis will determine if any extra requirements for the product design, development process, production process or maintenance, example the complete product life cycle.

Warning

All brands and all types of directional control or proportional valves, which are used in many different operation conditions and applications, can fail and cause serious damage. Analyze all aspects of the application. The machine builder/system integrator alone is responsible for making the final selection of the products and assuring that all performance, safety and warning requirements of the application are met. The process of choosing the control system and safety levels is governed by the machine directives EN 13849 (Safety related requirements for control systems).

Safety in application

Example of a control system for manlift

Example of a control system for man-lift



Example of a control system for man-lift using PVE Fault monitoring input signals and signals from external sensors to ensure the PLUS+1® main controllers correct function of the man-lift.

Typical PVE wiring block diagram

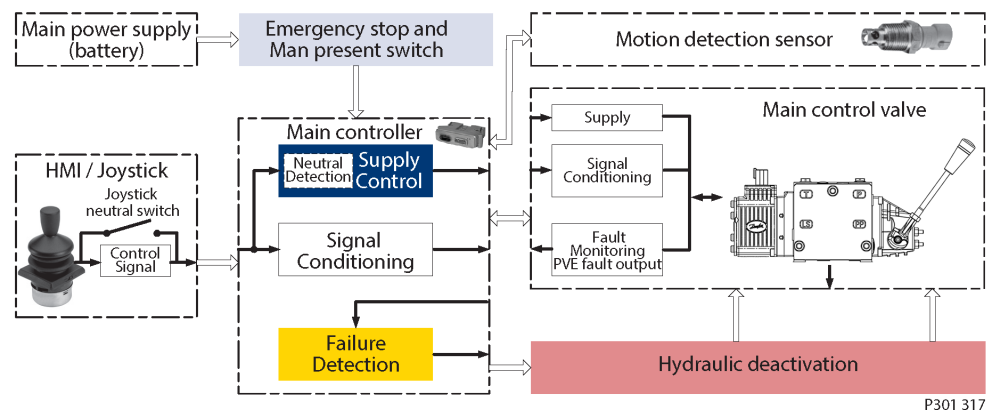

⚠ Warning

It is the responsibility of the equipment manufacturer that the control system incorporated in the machine is declared as being in conformity with the relevant machine directives.

Safety in application

PVG 32 – used in system with fixed displacement pumps:

- PVSK, commonly used in crane application - full flow dump
- PVPX, LS dump to tank

PVG 100 – alternative LS dump/pilot supply disconnect:

- PVPP, pilot oil supply shut off
- External cartridge valve connecting LS pressure or main pressure to tank

PVG 120 – pump disconnect/block for variable pumps:

- PVPE, full flow dump for the PVG 120
- External cartridge valve connecting LS pressure to tank

Safety in application

Examples of wiring block diagram

Example 1

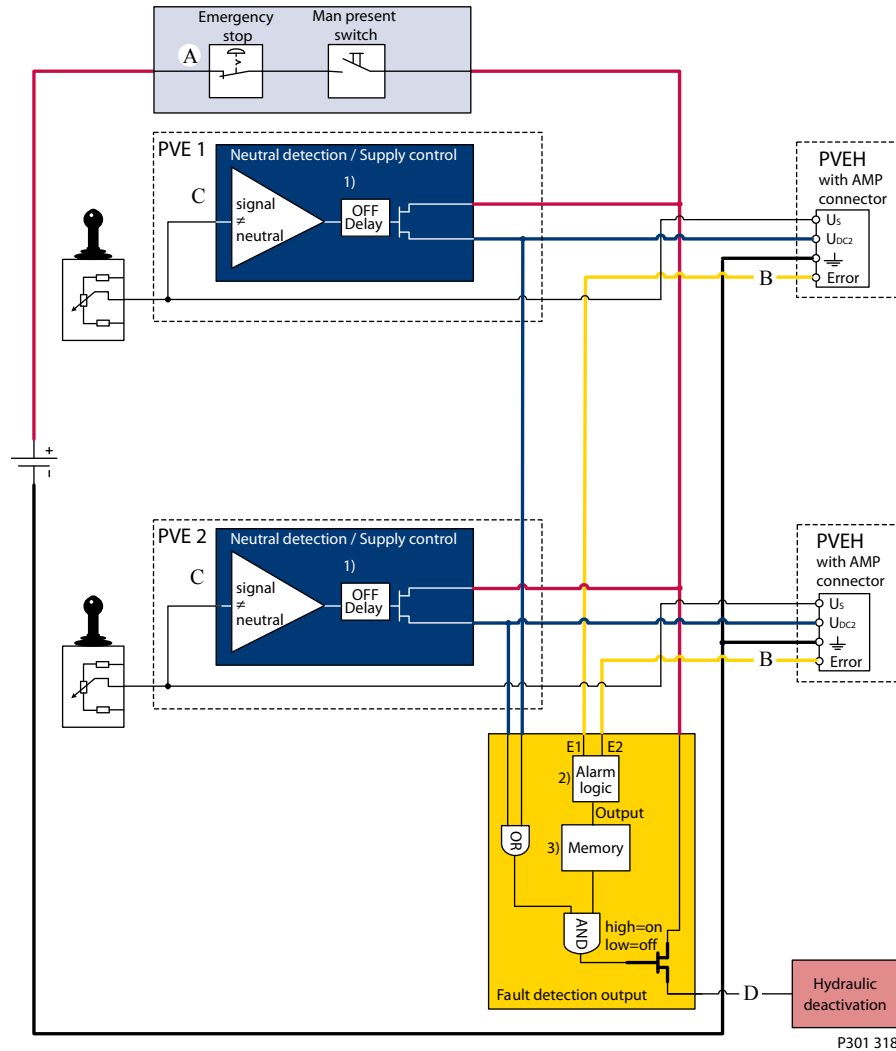

Typical wiring block diagram using PVEH with neutral power off switch and fault monitoring output for hydraulic deactivation.

- A** Emergency stop / man present switch
- B** PVE Fault monitoring signals
- C** Neutral signal detection
- D** Deactivation of the hydraulic system (System Control Logic, example: PLUS+1® for signal monitoring and triggering signal)

⚠ Warning

It is the responsibility of the equipment manufacturer that the control system incorporated in the machine is declared as being in conformity with the relevant machine directives.

Safety in application

Example 2

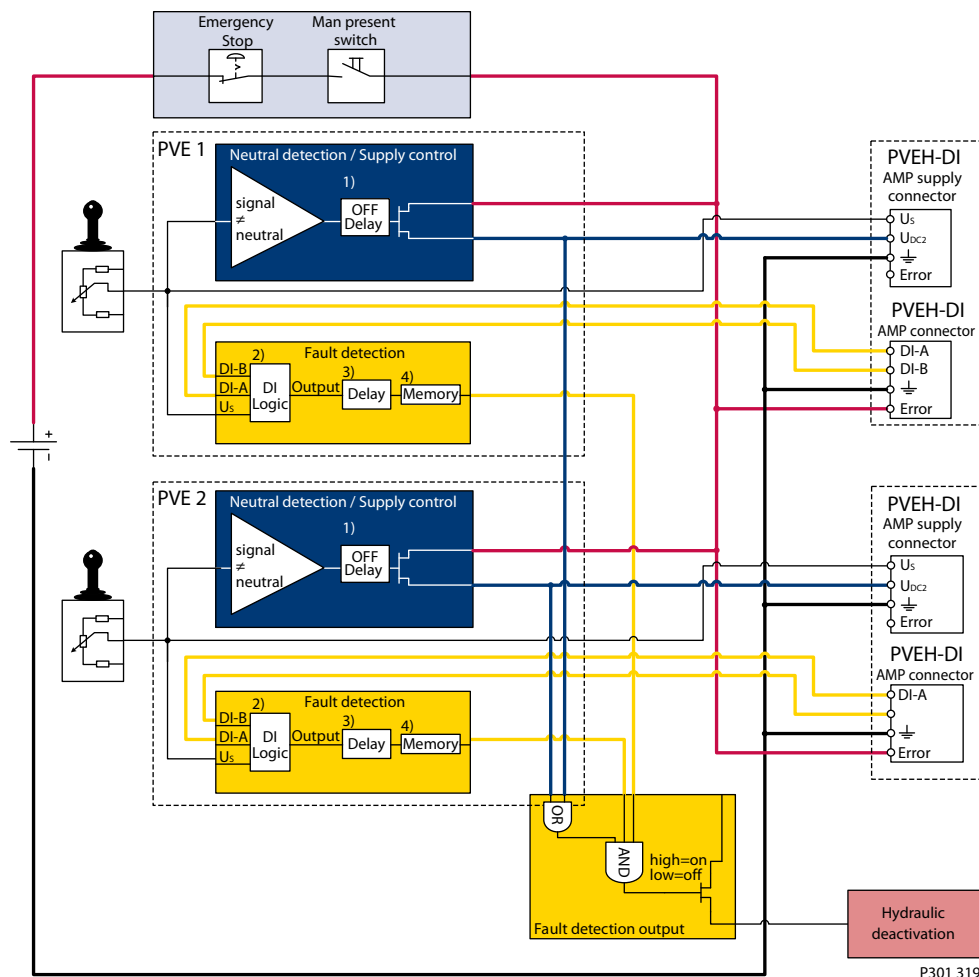

P301 319

Fault monitoring for deactivation of the hydraulic system with extra fault inputs using the PVE's with DI (Direction Indication) function. System Control Logic, example PLUS+1® for signal monitoring and triggering signal for deactivation of the hydraulic system.

⚠ Warning

It is the responsibility of the equipment manufacturer that the control system incorporated in the machine is declared as being in conformity with the relevant machine directives.

Function

There is a wide range of pressure settings and fluid flow controls.

Load sensing controls

The LS control matches system requirements for both pressure and flow in the circuit regardless of the working pressure. Used with a closed center control valve, the pump remains in low-pressure standby mode with zero flow until the valve is opened. The LS setting determines standby pressure.

Typical operating curve

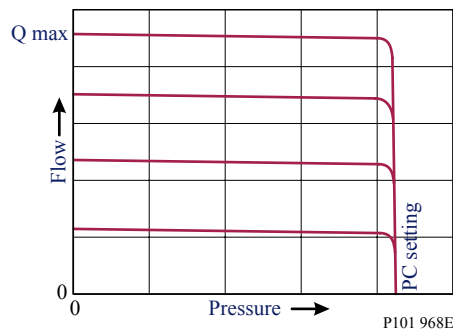

Load sensing circuit

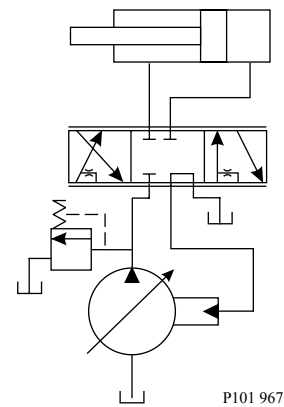

Most load sensing systems use parallel, closed center, control valves with special porting that allows the highest work function pressure (LS signal) to feed back to the LS control.

Margin pressure is the difference between system pressure and the LS signal pressure. The LS control monitors margin pressure to read system demand. A drop in margin pressure means the system needs more flow. A rise in margin pressure tells the LS control to decrease flow.

LS control with bleed orifice (do not use with PVG valves)

The load sense signal line requires a bleed orifice to prevent high-pressure lockup of the pump control. Most load-sensing control valves include this orifice. An optional internal bleed orifice is available, for use with control valves that do not internally bleed the LS signal to tank.

Integral PC function

The LS control also performs as a PC control, decreasing pump flow when system pressure reaches the PC setting. The pressure compensating function has priority over the load sensing function.

[For additional system protection, install a relief valve in the pump outlet line.](#)

Load sensing system characteristics:

- Variable pressure and flow
- Low pressure standby mode when flow is not needed
- System flow adjusted to meet system requirements
- Lower torque requirements during engine start-up
- Single pump can supply flow and regulate pressure for multiple circuits
- Quick response to system flow and pressure requirements

Function

Remote pressure compensated controls

The remote PC control is a two-stage control that allows multiple PC settings. Remote PC controls are commonly used in applications requiring low and high pressure PC operation.

Typical operating curve

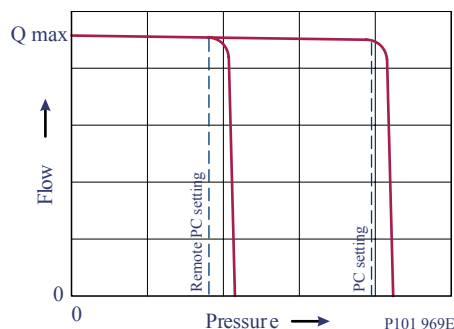

Closed center circuit with remote PC

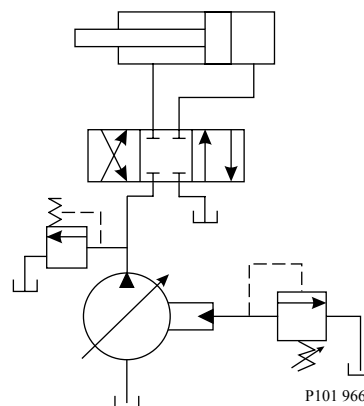

The remote PC control uses a pilot line connected to an external hydraulic valve. The external valve changes pressure in the pilot line, causing the PC control to operate at a lower pressure. When the pilot line is vented to reservoir, the pump maintains pressure at the load sense setting.

When pilot flow is blocked, the pump maintains pressure at the PC setting. An on-off solenoid valve can be used in the pilot line to create a low-pressure standby mode. A proportional solenoid valve, coupled with a microprocessor control, can produce an infinite range of operating pressures between the low pressure standby setting and the PC setting.

[Size the external valve and plumbing for a pilot flow of 3.8 l/min \[1 US gal/min\]. For additional system protection, install a relief valve in the pump outlet line.](#)

Remote pressure compensated system characteristics:

- Constant pressure and variable flow
- High or low pressure standby mode when flow is not needed
- System flow adjusts to meet system requirements
- Single pump can provide flow to multiple work functions
- Quick response to system flow and pressure requirements

Typical applications for remote pressure compensated systems:

- Modulating fan drives
- Anti-stall control with engine speed feedback
- Front wheel assist
- Road rollers
- Combine harvesters
- Wood chippers

PVPC with check valve for open center PVP

PVPC with check valve is used in systems where it is necessary to operate the PVG 32 valve by means of the electrical remote control without pump flow. When the external solenoid valve is opened, oil from the pressure side of the cylinder is fed via the PVPC through the pressure reducing valve to act as the

Function

pilot supply for the electrical actuators. This means that a load can be lowered by means of the remote control lever without starting the pump.

The built-in check valve prevents the oil from flowing via the pressure adjustment spool to tank. With the pump functioning normally the external solenoid valve is closed to ensure that the load is not lowered due to the pilot supply oil flow requirement of approximately 1 l/min [0.25 US gal/min]. With closed center PVP the external pilot oil supply can be connected to the pressure gauge connection without the use of a PVPC plug.

PVPC with check valve for OC PVP

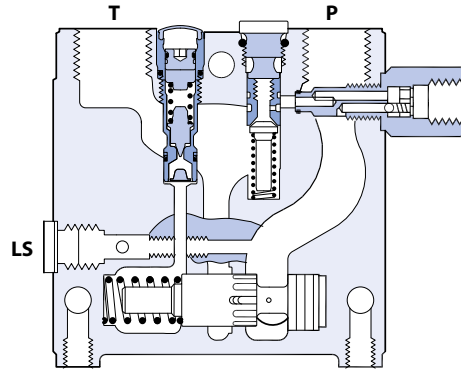

157-114.11

Hydraulic diagram

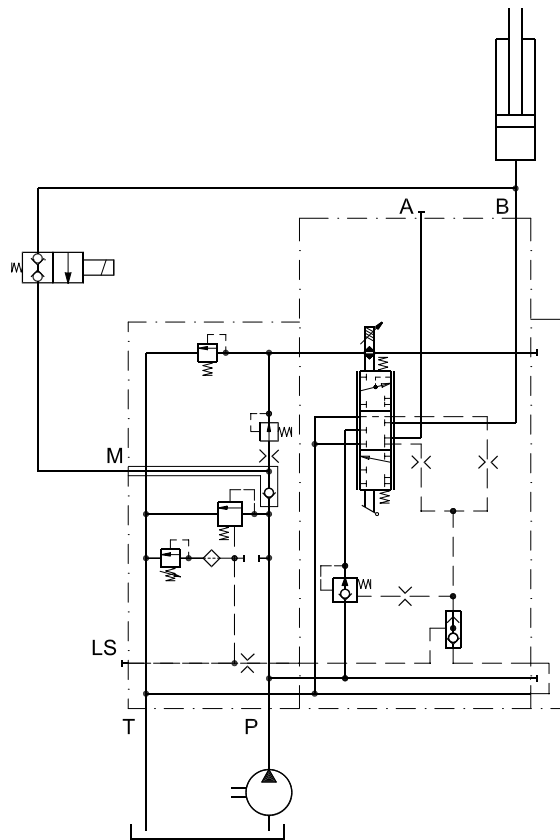

157-116.10

Function

PVPC without check valve for open or closed center PVP

PVPC without check valve is used in systems where it is necessary to supply the PVG 32 valve with oil from a manually operated emergency pump without directing oil flow to the pilot oil supply (oil consumption about 0.5 l/min) [0.13 US gal/min].

When the main pump is working normally, the oil is directed through the PVPC plug via the pressure reduction valve to the electrical actuators.

PVPC without check valve OC/CC PVP

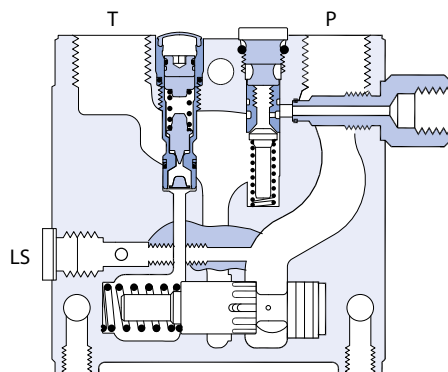

157-193.11

Hydraulic diagram

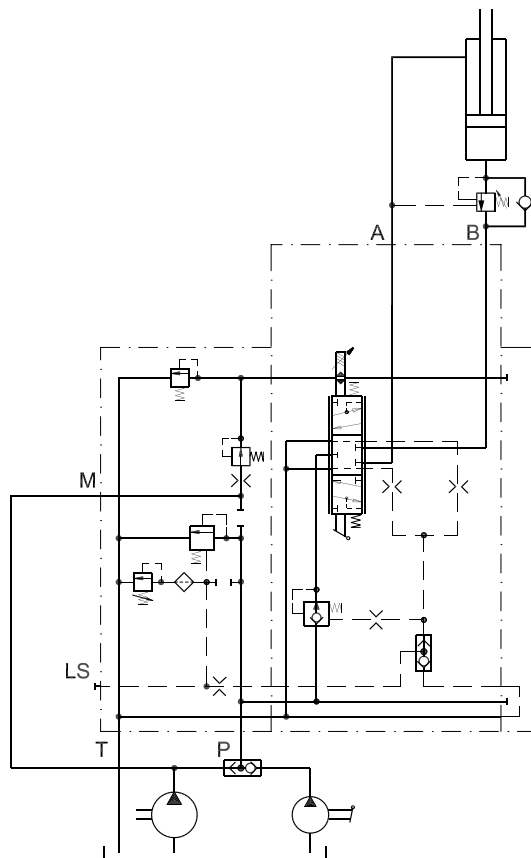

157-194.11

Function

When the main pump flow fails, the external shuttle valve ensures that the oil flow from the manually operated emergency pump is used to pilot open the over center valve and lower the load. The load can only be lowered using the mechanical operating lever of the PVG 32 valve.

PVMR, friction detent

The friction detent PVMR allows the directional spool to be held in any position, resulting in infinitely variable, reversible, pressure compensated flow.

This can be sustained indefinitely without having to continue to hold the mechanical lever. Friction detent spool position may be affected by high differential actuator flow forces and system vibration resulting in work function flow reduction.

PVMR, friction detent

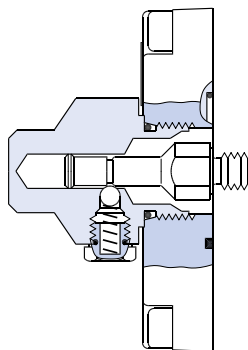

157-204.10

PVMF, mechanical float position lock

Allows the float spool to be held in the float position after release of the mechanical handle.

PVMF, standard mount only

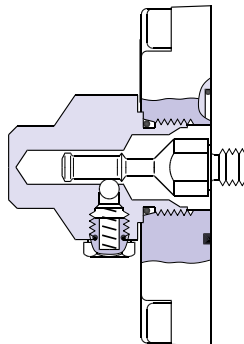

157-205.10

P → A → F (Push-in)

PVMF, optional mount only

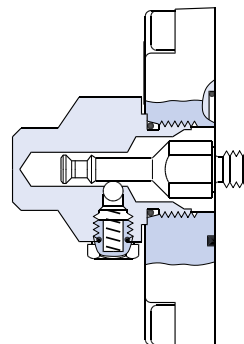

157-206.10

P → A → F (Pull-out)

PVBS, main spools for flow control (standard)

When using standard flow control spools, the pump pressure is determined by the highest load pressure. This is done either via the pressure adjustment spool in open center PVP (fixed displacement pumps) or via the pump control (variable displacement pumps).

In this way the pump pressure will always correspond to the load pressure plus the stand-by pressure of the pressure adjustment spool or the pump control. This will normally give optimum and stable adjustment of the oil flow.

Function

PVBS, main spools for flow control (linear characteristic)

PVBS main spools with linear characteristic have less dead band than standard spools and a proportional ratio between control signal and oil flow in the range beyond the dead band. PVBS with linear characteristic must never be used together with PVEM electrical actuators.

The interaction between the small dead band of the spools and the hysteresis of the PVEM actuator of 20% involves a risk of building up a LS pressure in neutral position.

In a few systems load sensing pump pressure may result in unstable adjustment of the oil flow and a tendency towards system hunting.

This may be the case with working functions that have a large moment of inertia or over-center valves. In such systems main spools for pressure control can be advantageous.

Function

PVBS, main spools with pressure compensated control

The PC control maintains constant system pressure in the hydraulic circuit by varying the output flow of the pump. Used with a closed center control valve, the pump remains in high pressure standby mode at the PC setting with zero flow until the function is actuated.

Typical operating curve

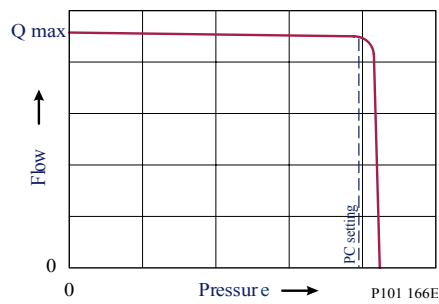

Simple closed center circuit

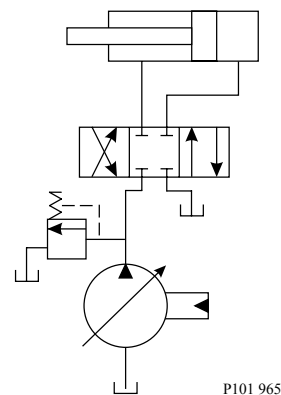

Once the closed center valve is opened, the PC control senses the immediate drop in system pressure and increases pump flow by increasing the swashplate angle.

The pump continues to increase flow until system pressure reaches the PC setting.

If system pressure exceeds the PC setting, the PC control reduces the swashplate angle to maintain system pressure by reducing flow. The PC control continues to monitor system pressure and changes swashplate angle to match the output flow with the work function pressure requirements.

If the demand for flow exceeds the capacity of the pump, the PC control directs the pump to maximum displacement. In this condition, actual system pressure depends on the actuator load.

[For additional system protection, install a relief valve in the pump outlet line.](#)

Pressure compensated system characteristics

- Constant pressure and variable flow
- High pressure standby mode when flow is not needed
- System flow adjusts to meet system requirements
- Single pump can provide flow to multiple work functions
- Quick response to system flow and pressure requirements

Typical applications for pressure compensated systems

- Constant force cylinders (bailers, compactors, refuse trucks)
- On/off fan drives
- Drill rigs
- Sweepers
- Trenchers

Function

PVBS, main spools for pressure control

The spools are designed in such a way that the pump pressure is controlled by the spool travel. The main spool must be displaced until the pump pressure just exceeds the load pressure before the working function is applied. If the main spool is held in this position, the pump pressure will remain constant – even if the load pressure changes – giving a stable system.

The use of pressure control spools, however, also means that:

- the oil flow is load dependent
- the dead band is load dependent
- the pump pressure can exceed the load pressure by more than is usual
- the pressure drop across main spool varies (energy consumption)

Due to these factors it is recommended that pressure control spools are only used when it is known for certain that problems with stability will arise or already have arisen, and in applications where constant pressure is needed e.g. drill holding.

Background

Instability in load sense control systems in certain applications with oscillations in the range of 1/2 - 2 Hz can cause severe instability problems while trying to control functions in an application.

Critical applications are usually related to functions with an important inertia torque and/or functions with secondarily fitted pressure controlled components e.g. over-center valves.

Examples:

- a slewing function
- main lifting/lowering function of a crane

The problem usually manifests itself in prolonged oscillation phenomena (Fig. 1), in a relatively constant sequence of oscillations (Fig. 2) or in the worst case in an amplified sequence of oscillations (Fig. 3).

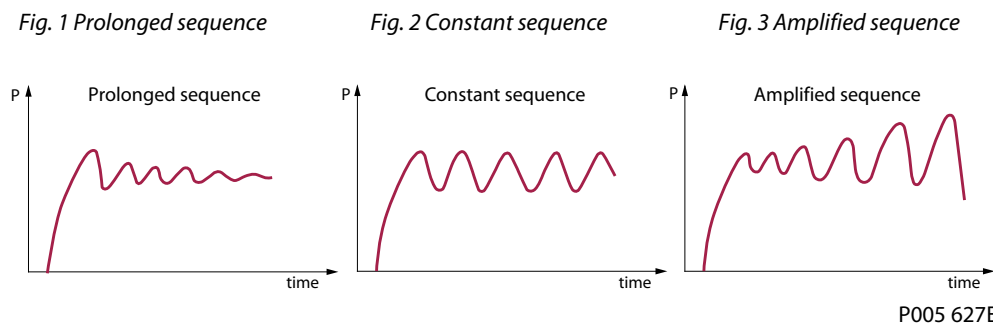

P005 627E

To control the oscillation phenomena the "pressure control spool" was developed and is a patented system which can minimize most of the oscillation issues.

PVG 32 Principle

The idea was to create a system operating independently of a constantly changing load pressure. Therefore, we changed the well-known LS principle (Fig. 4), so that compensated pump pressure is part of the LS system (Fig. 5) after the pressure compensator and before the metering range of the main spool. Upon actuation of the spool, it will be led via a fixed and a variable orifice.

Function

Fig. 4 Flow controlled spool

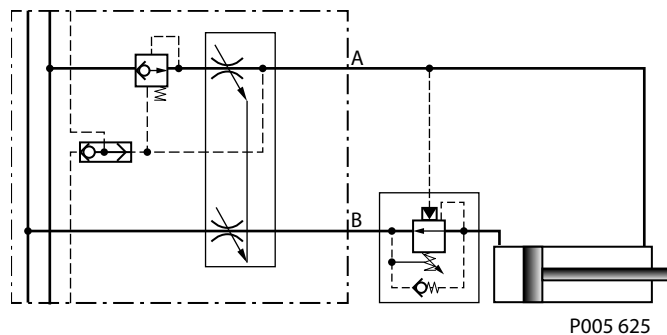
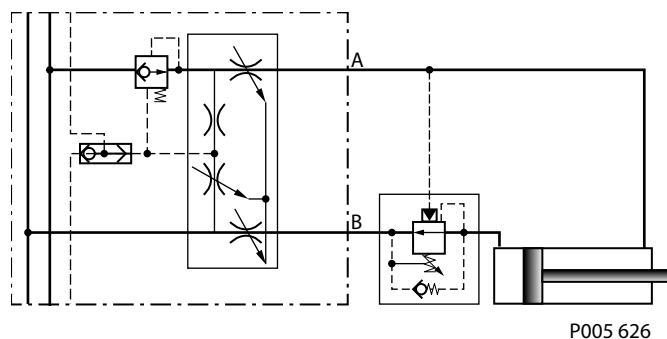

Fig. 5 Pressure controlled spool



The opening area of the variable orifice is at maximum at initial actuation and 0 at full stroke of the spool and then the pressure created between the two orifices is led into the LS system in the usual way.

In this way the pump pressure is built up depending on the spool travel, e.g. the spool will then have to be stroked to a position that the pump pressure is higher than the actual load pressure to make the oil flow from P→A/B.

When the load changes for a fixed spool position the flow to for the function will also change.

The valve section is now a load-dependent valve, but ensuring a constant pump pressure which is important in obtaining a stable function.

Pump pressure vs. spool travel curve

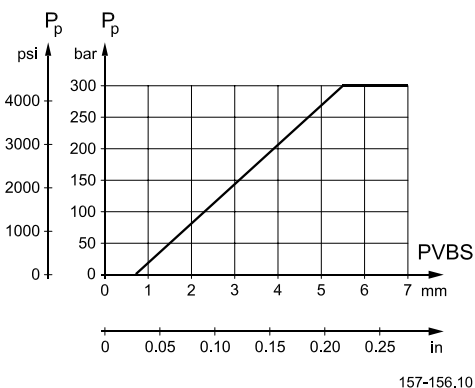

Pressure controlled spool application

Pressure controlled spools should in principle only be used when you have stability issues. Typical applications on a crane:

Function

- Lifting/lowering movement
- Slewing movement with cylinders
- For the main lifting/lowering function on a crane it is recommended to fit a "half" pressure control spool. This means that the spool is designed with a normal flow control on the lifting port and pressure control connected to the port where the pilot signal to the over-center valve is acting. You will thus maintain a load-independent lifting movement and achieve a stable but load-dependent lowering movement.
- As the load pressure on slewing movements is usually steady - irrespective of the crane being loaded or not - it will be advantageous to use a "full" pressure control spool for A and B port.

In both cases we recommend the use of a basic valve, PVB, with pressure compensator. The pressure compensator will ensure the individual load-independency between the basic valves.

It is further recommended to use the LS pressure relief valves as not only will they ensure individual pressure limitation but also make it possible to adjust the maximum oil flow to the function.

It is not recommended to use shock valves as pressure limiting valves in connection with pressure control spools.

Sizing

The size of "half" (e.g. P - A = flow control P - B pressure control) pressure control spools is determined on basis of max. flow demand on the lifting port. If e.g. a max. pressure compensated flow of 65 l/min for the lifting movement, you choose a 65 L/min spool (size D). The metering characteristic has then a given size. As it is often requested to limit the use of the crane boom for downward push/force mode and the LS pressure limitation can be used. It will appear from the characteristics enclosed what effect a pressure limitation, P_{LS} will have on max. flow on the lowering port.

The size for a "full" pressure control spool is determined on basis of known load pressure, P_{LS} max, and requested max. flow.

It will appear from the characteristics enclosed that if the load PLS is low and the pump pressure, P_p , is high as a result of max. stroked spool you will get a large flow.

If P_{LS} is approaching PLS max. the flow will be reduced and the dead band increased. Max. oil flow can be reduced by approx. 50% without limiting max. pressure.

The reduction is made by limiting the spool travel from 7 mm to 5.5 mm.

Limitation

If a pressure controlled spool is chosen for stability reasons consideration should be made to features related to the pressure control principle.

Deadband will change according to the load conditions and the valve section will become load-dependent and that the pump pressure may exceed the load pressure.

With all of the above in mind, a "pressure controlled spool" will minimize oscillation and obtain a stable function that can be controlled smooth and precise.

Function

PVPX, electrical LS unloading valve

PVPX is a solenoid LS unloading valve. PVPX is fitted into the pump side module enabling a connection to be made between the LS and the tank lines. Thus the LS signal can be relieved to tank by means of an electric signal.

For a PVP pump side module in open center version the relief to tank of the LS signal means that the pressure in the system is reduced to the sum of the tank port pressure plus the neutral flow pressure for the pump side module.

For a PVP pump side module in closed center version the relief to tank of the LS signal means that the pressure is reduced to the sum of the tank port pressure for the pump side module plus the stand-by pressure of the pump.

PVPX, electrical LS unloading valve

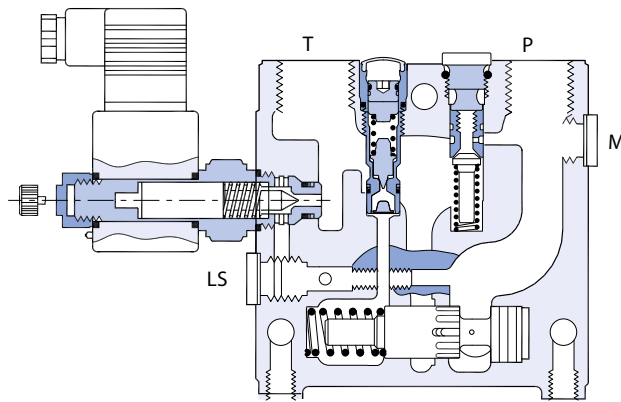

157-195.11

PVG 32 Technical Data

Operating parameters

Maximum rated pressure	A/B, P-port continuous ¹⁾	350 bar [5076 psi]
	P-port intermittent ²⁾	400 bar [5800 psi]
	A/B-port intermittent ²⁾	420 bar [6090 psi]
	T-port static/dynamic	25/40 bar [363/580 psi]
Oil rated flow	P-port ³⁾⁴⁾	140/230 l/min [37/61 US gal/min]
	Port A/B, with press. comp. ⁵⁾	100 l/min [26.4 US gal/min]
	Port A/B, without press. comp.	120 l/min [33 US gal/min]
Max. internal leakage at 100 bar [1450 psi]	A/B → T without shock valve	20 cm ³ /min [1.85 in ³ /min]
	A/B → T with shock valve	25 cm ³ /min [2.15 in ³ /min]
Oil temperature	Recommended	30 to 60°C [86 to 140°F]
	Minimum	-30°C [-22°F]
	Maximum	90° [194°F]
Ambient temperature	Recommended	-30 to 60°C [-22 to 140°F]
Oil viscosity	Operating range	12 to 75 mm ² /s [65 to 347 SUS]
	Minimum	4 mm ² /s [39 SUS]
	Maximum	460 mm ² /s [2128 SUS]
Oil cleanliness	Minimum	23/19/16 (according to ISO 4406)

¹⁾ With PVS1 end plate; with PVS end plate max. 300 bar [4351 psi].

²⁾ Intermittent pressure at max. 250,000 cycles of full PVG life time cycles, with PVS1 end plate. The maximum intermittent pressure at max. 250,000 cycles stresses the need to confirm application duty cycle before proceeding with specification. For further information contact Danfoss Product Application Engineering.

³⁾ In open circuit systems with short P-hoses/tubes, attention should be paid to pressure peaks at flows >100 l/min [26.4 US gal/min].

⁴⁾ For a system with mid inlet PVPVM.

⁵⁾ In open circuit systems with short P-hoses/tubes, For 130 l/min flow contact Danfoss Product Application Engineering.

Spool data

Spool travel	Standard	± 7 mm [± 0.28 in]
	Proportional range	± 4.8 mm [± 0.19 in]
	Float position	± 8 mm [± 0.32 in]
Dead band, flow control spools	Standard	± 1.5 mm [± 0.06 in]
	Linear characteristic	± 0.8 mm [± 0.03 in]

On standard PVB 32 modules, using main spools with closed neutral position, there will be a pressure build up on the A and B port, when main spool is in neutral, and high P pressure. The pressure build up equals to 0,5x P-pressure can be expected.

If this is causing problems on applications, please contact PVG sales team.

Rated pressure

Product	P-port max. continuous pressure
PVG 32; PVG 120/32; PVG 100/32 with PVS	300 bar [4351 psi]
PVG 32; PVG 120/32; PVG 100/32 with PVS1	350 bar [5076 psi]
PVG 32 with PVBZ	250 bar [3626 psi]
PVG 32 with HIC steel	350 bar [5076 psi]
PVG 32 with HIC aluminum	210 bar [3046 psi]

PVG 32 Technical Data

PVM operating force

Operating torque for PVM

Spool displacement	Operating torque N·m [lb·in]			
	PVM + PVMD, PVE	PVM + PVH	PVM + PVMR	PVM+PVMF
From neutral position	2.2 ±0.2 [19.5 ±1.8]	2.5 ±0.2 [22.1 ±1.8]	17 [3.8]	22 [5.0]
Max. spool travel	2.8 ±0.2 [24.8 ±1.8]	6.9 ±0.2 [61.0 ±1.8]	–	–
Into float position	–	–	–	60 [13.5]
Away from float position	–	–	–	28 [6.3]
From any other position	–	–	8.5 [73.3]	–

PVH, hydraulic actuation

PVH, Hydraulic Actuation

PVH data	Pressure, bar [psi]
Control range	5 to 15 [75 to 220]
Maximum pilot pressure, static	30 [435]
Maximum pressure on port T (It is recommended that the tank connection from the hydraulic remote control unit PVRH is taken directly to tank.)	10 [145]

PVE actuation literature reference

For the information about the available electrohydraulic actuator variants, please see the following documents overview.

PVE actuation literature reference

Title	Type	Lit. Number
Electrohydraulic Actuators, PVEO/M/A/H/S Series 7	Technical Information	BC00000378
Electrohydraulic Actuators, PVE Series 4 and PVHC	Technical Information	BC00000050
Electrohydraulic Actuators, PVED-CC Series 5 ISObus	Technical Information	BC00000361
Electrohydraulic Actuators, PVED-CC Series 5 CANopen	Technical Information	BC00000354
Electrohydraulic Actuators, PVED-CC Series 4	Technical Information	BC00000107
Electrohydraulic Actuators, PVED-CX Series 4	Technical Information	BC00000068

Technical characteristics

The measured characteristics in this catalog are typical measured values.

During measuring a mineral based hydraulic fluid with a viscosity of 21 mm²/s [102 SUS] at a temperature of 50 °C [122 °F] was used.

PVP pressure relief valve characteristics

The pressure relief valve is set at an fluid flow of 15 l/min [4 US gal/min]. Pressure setting range for PVP with PVS1 end plate is 30 to 350 bar [435 to 5075 psi] and for PVP with PVS end plate is 30 to 300 bar [435 to 4351 psi].

Pressure relief valve characteristic

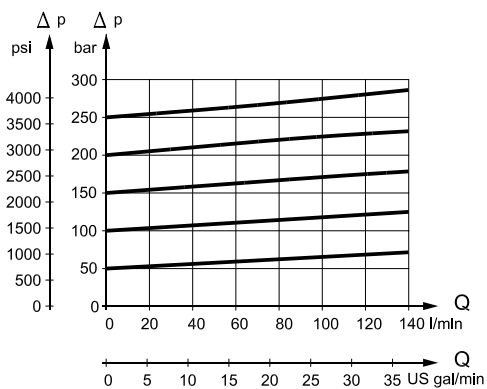

157-83.10

Neutral by-pass pressure drop (open center)

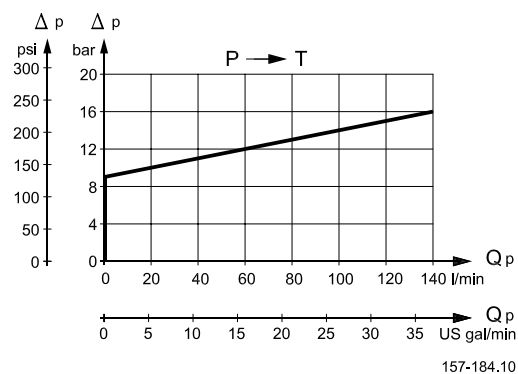

157-184.10

Technical characteristics

PVB, basic modules oil flow characteristics

The fluid flow for the individual spool depends on type of basic module (with/without compensation) and type of pump (fixed or variable displacement).

Linear fluid flow depending on spool type

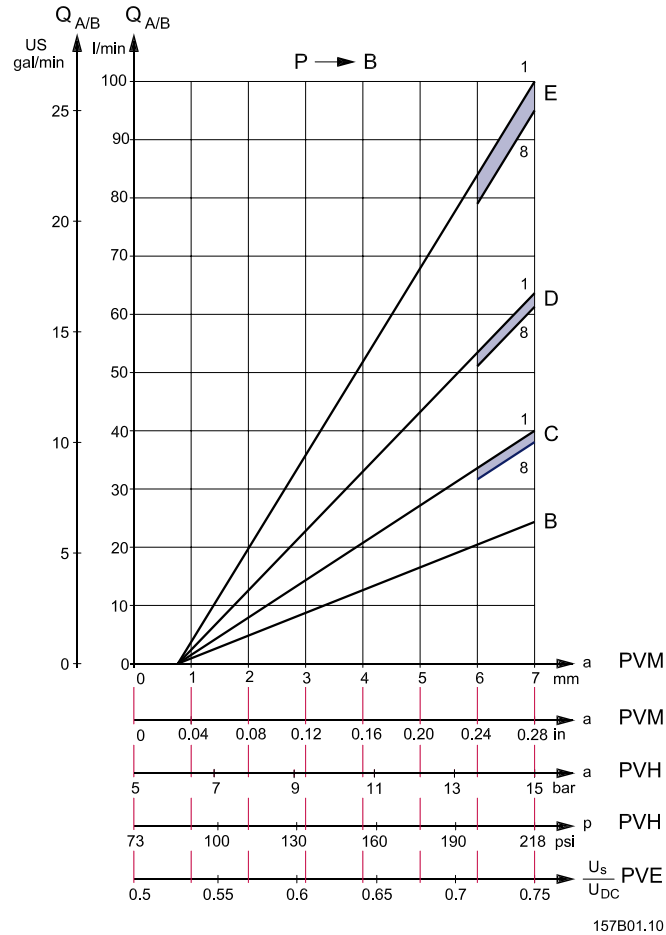

U_s = Signal voltage; U_{DC} = Supply voltage; 1 = First PVB after PVP; 8 = Eighth PVB after PVP

Technical characteristics

Pressure-compensated PVB, open center PVP

The fluid flow is dependent on the supplied pump fluid flow.

The characteristics are plotted for a pump oil flow, Q_p , corresponding to the rated maximum spool oil flow, Q_N . Increasing the pump oil flow to $1,4 \times Q_N$ will give the same oil flow on the eighth as on the first basic module.

The letters AA, A, B, C, D, E denote spool types. The characteristic below is shown for spool travel in both directions. All other characteristics are shown for spool travel in one direction only.

Progressive oil flow characteristic depending on spool type

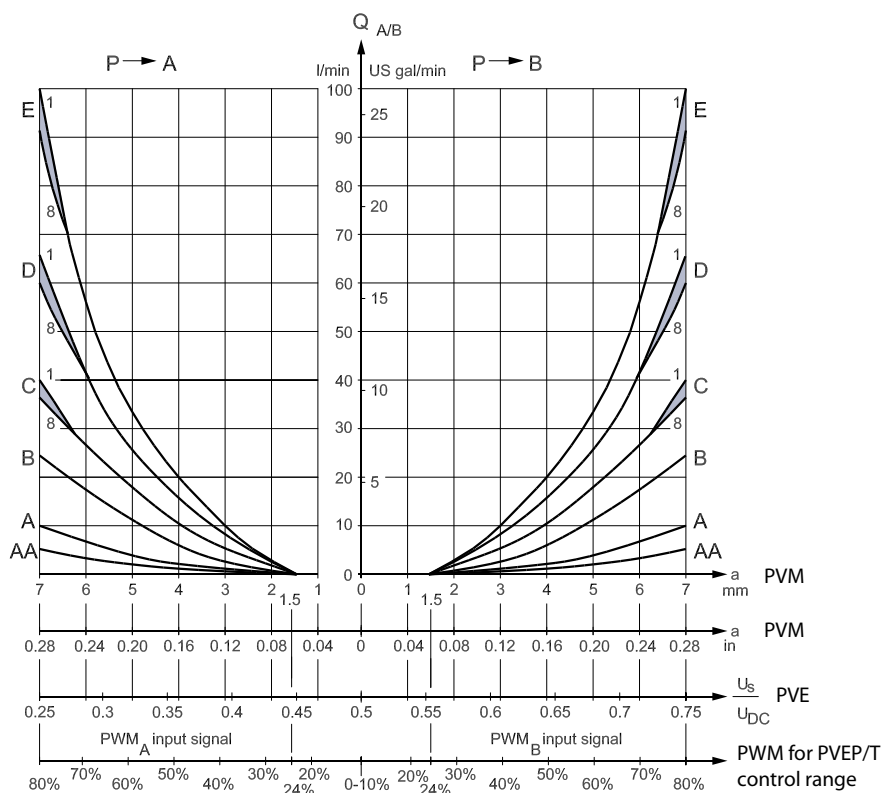

157-61.im

U_s = Signal voltage; U_{DC} = Supply voltage; 1 = First PVB after PVP; 8 = Eighth PVB after PVP

Technical characteristics

PVB without pressure compensation, open center PVP

The spool flow $Q_{A/B}$ is dependent on the supplied pump fluid flow, Q_p .

The characteristics apply to supply oil flow of 130 l/min [34.3 US gal/min] with the actuation of one basic module and the supply flow level. If several basic modules are activated at the same time, the characteristic depends on the load pressure of the actuated basic modules. The pressure drop of any oil flowing back to tank ($Q_p - Q_{A/B}$) is read on the curve for neutral flow pressure in PVP.

Fluid flow as a function of spool travel

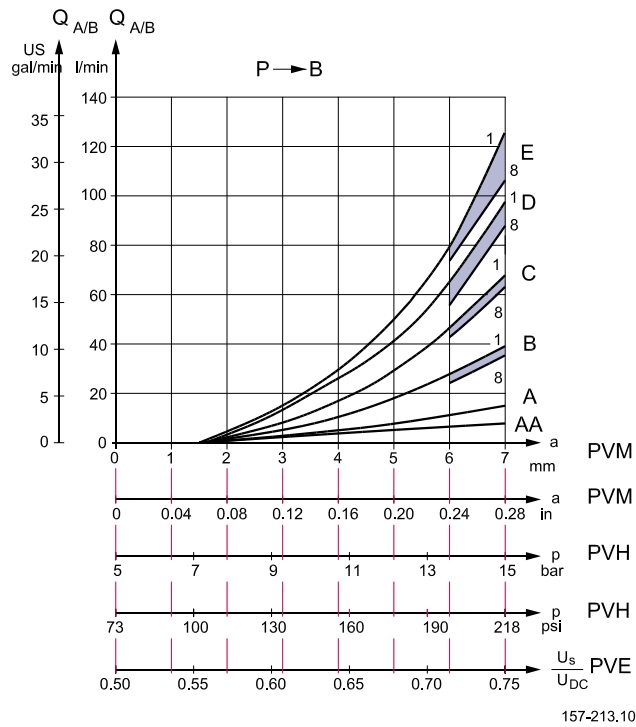

Technical characteristics

Characteristic for fully displaced flow control spools

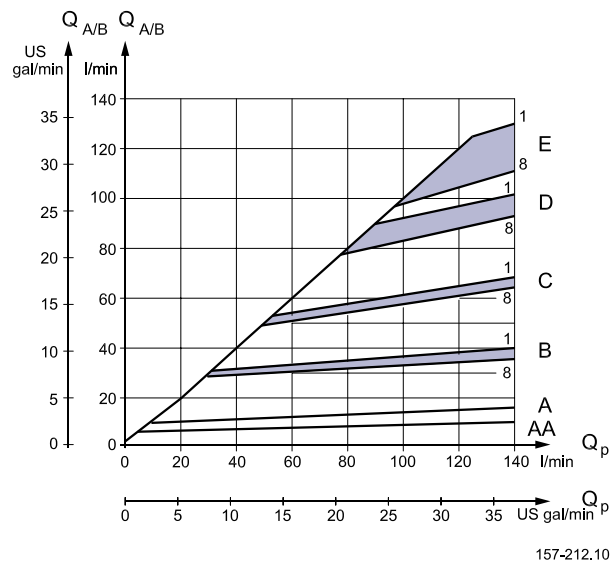

Technical characteristics

PVB without pressure compensation, closed center PVP

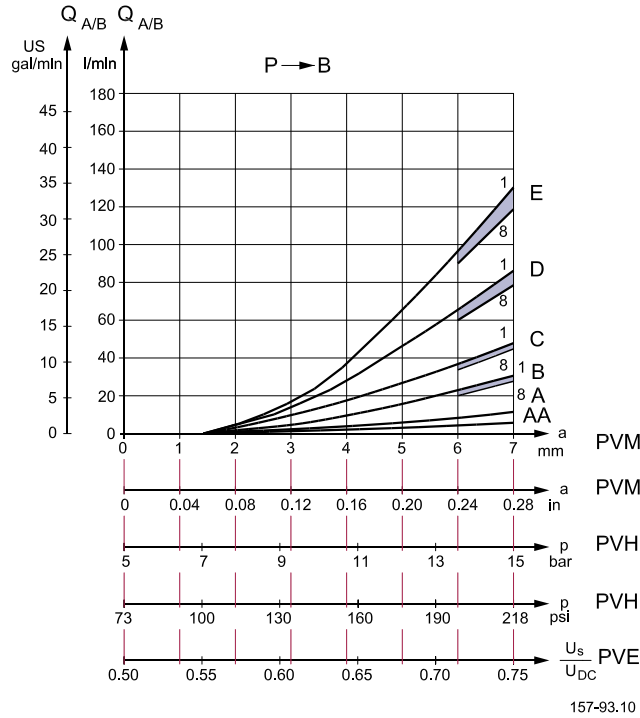

Set pressure difference between pump pressure and LS signal = 10 bar [145 psi].

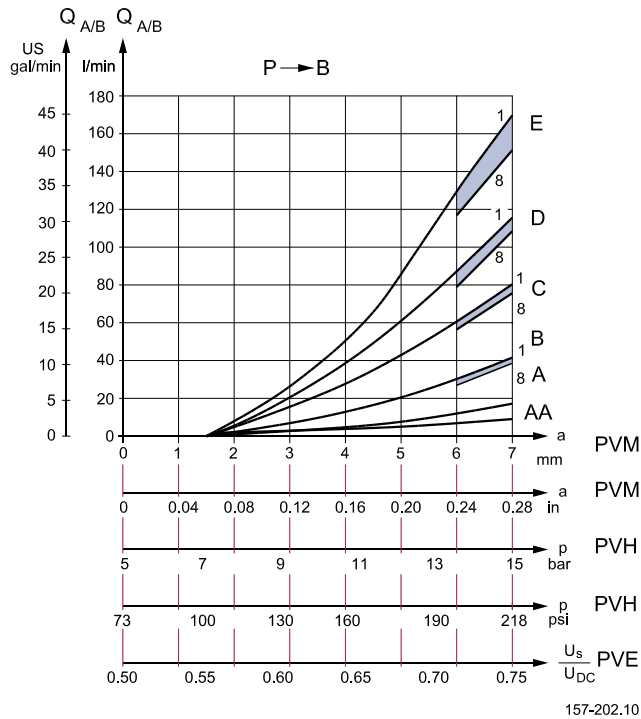

Set pressure difference between pump pressure and LS signal = 20 bar [290 psi].

Technical characteristics

The oil flow is dependent on the pressure difference between the pump pressure and the LS signal. Normally the pressure difference is set at the LS pump regulator. Also take into consideration pressure drop from the pump to the PVG valve group, e.g. long pipeline.

Oil flow characteristics for PVB at

@ pressure drop at max. main spool travel

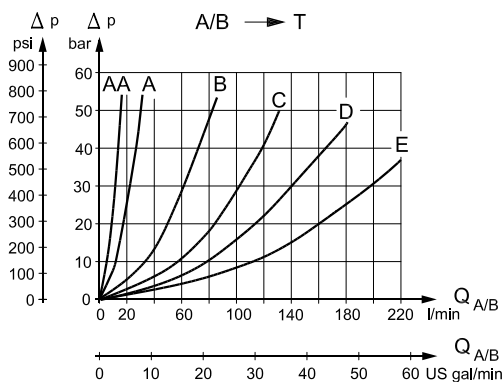

157-97.10

@ pressure drop for open spool in neutral position

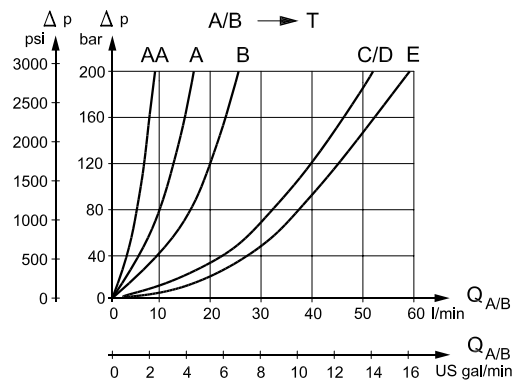

157-203.10

Load-independent, pressure-compensated

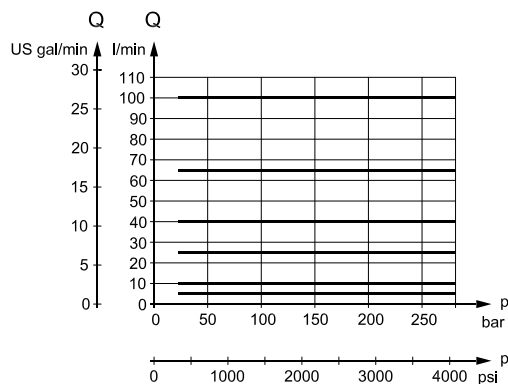

157-89.10

LS pressure limiting, pressure-compensated PVB

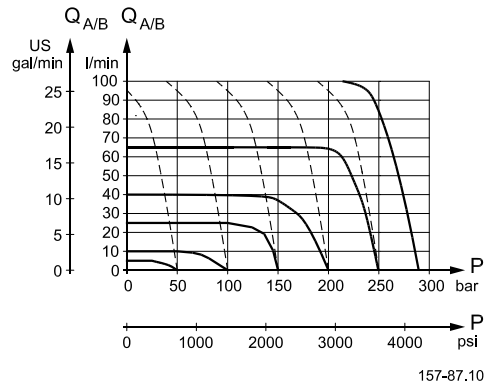

157-87.10

Technical characteristics

PVLP, shock and PVLA, suction valves

PVLP is set at an oil flow of 10 l/min [2.6 US gal/min]. The shock valve PVLP is designed to absorb shock effects. Consequently, it should not be used as a pressure relief valve.

If the working function requires the use of a pressure relief valve, a PVB basic module with built-in LS_{A/B} pressure limiting valve should be used.

PVLP, shock valve characteristic

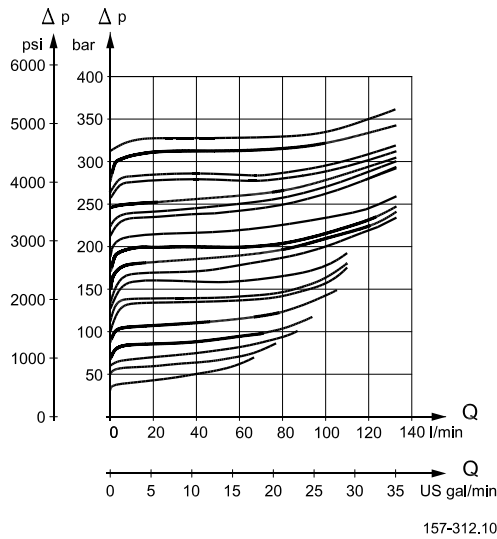

PVLA, suction valve characteristic

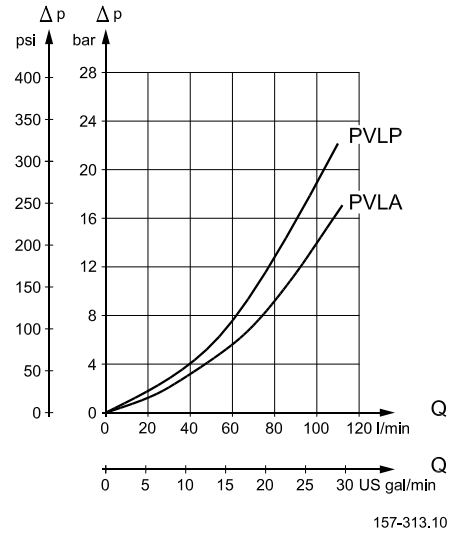

Pressure control spool flow characteristics

Size A:

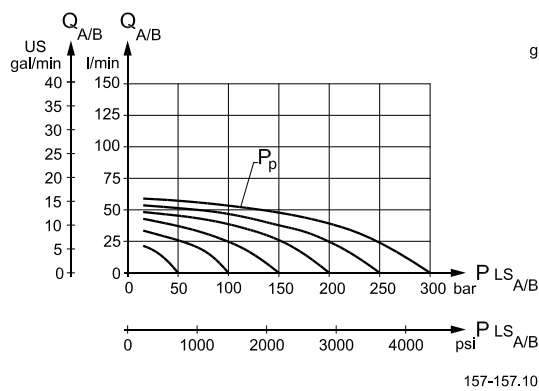

Size B:

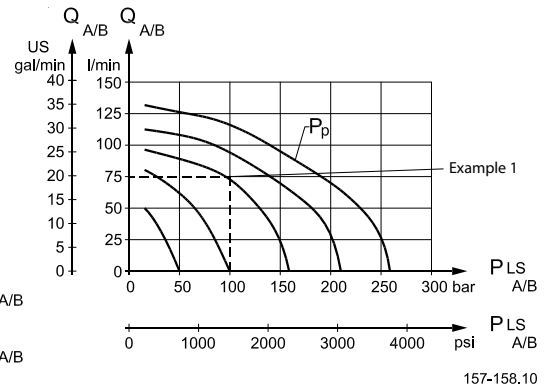

Technical characteristics

Size C:

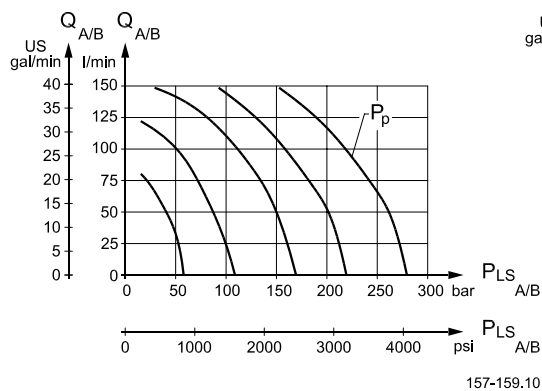

Size D:

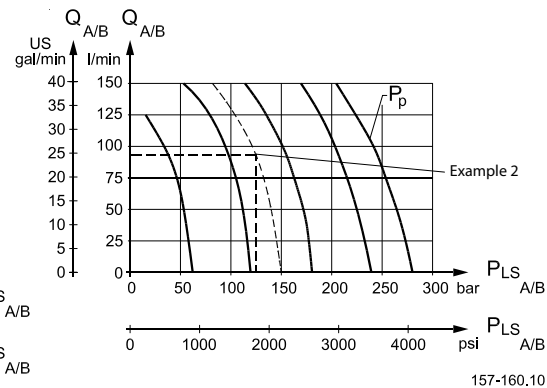

Size E:

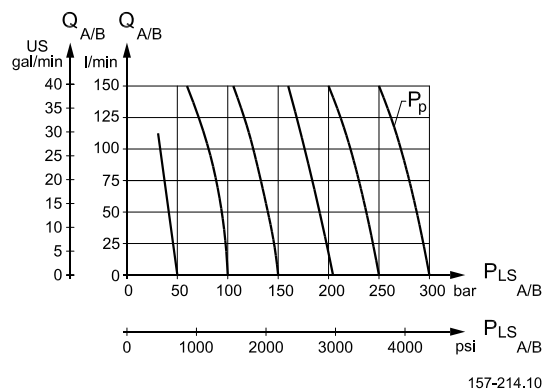

Technical characteristics

Pressure build-up for pressure controlled spools

Max. oil flow can be reduced by about 50% without limitation of maximum pressure by limiting the main spool travel from 7 mm [0.28 in] to 5.5 mm [0.22 in].

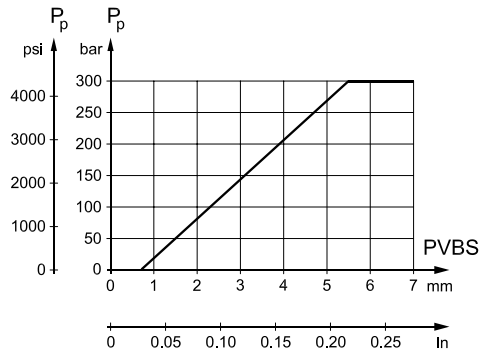

157-156.10

Examples of how to use the characteristics for pressure control spools

Example 1: Determining the oil flow

Given:

- Spool type B
- Pressure setting P_p : 160 bar [2320 psi]
- Load pressure, $LS_{A/B}$: 100 bar [1450 psi]

Result:

Oil flow = 75 l/min [19.8 US gal/min]

Example 2: Determining the spool size

Given:

- Max. oil flow, $Q_{A/B}$: 90 l/min [23.8 US gal/min]
- Pressure setting P_p : 150 bar [2175 psi]
- Load pressure, P_{LSA} : 125 bar [1810 psi]

Result: D spool

(see [Pressure CS flow characteristics](#), size D)

Normally a smaller spool can be chosen with pressure control. It is our experience that the spool can be one size smaller than with normal flow control.

Technical characteristics

Characteristics for float position main spools

Characteristic of oil flow, spool travel and voltage

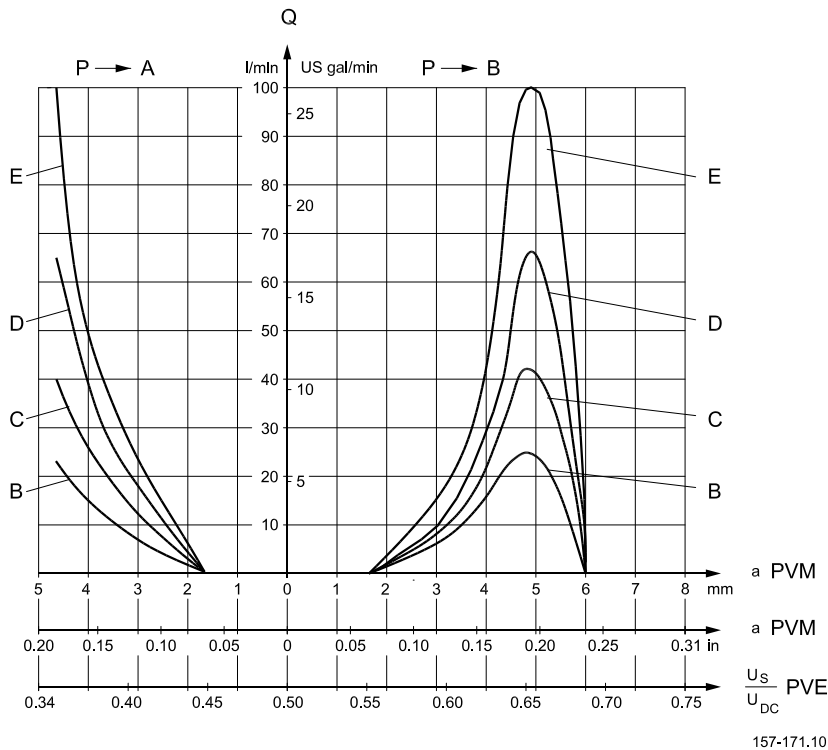

- 4.8 mm [0.19 in] spool displacement in direction A gives maximum oil flow to port A
- 4.8 mm [0.19 in] spool displacement in direction B gives maximum oil flow to port B
- 8 mm [0.32 in] spool displacement in direction B gives completely open float position A/B → T.

The spools have 4.8 mm spool travel in direction A and 8 mm travel in direction B:

For more information regarding electrical actuation of float spools please see *PVE series 4 Technical Information, 520L0553*.

Pressure drop A/B → T at maximum spool travel within the proportional range (4.8 mm) [0.19 in]

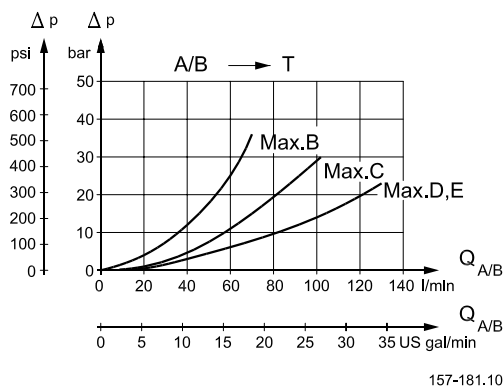

Spools D and E have the same opening area for forward flow and return flow.

Technical characteristics

Spool E can give 100 l/min [26.4 US gal/min] pressure compensated oil flow due to a higher pressure drop across spool E. This occurs during spool actuation only.

Pressure drop A/B → T in float position

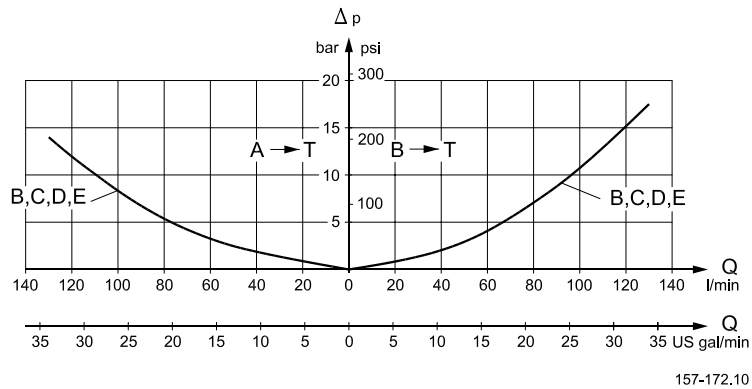

157-172.10

Hydraulic systems

Manually actuated PVG 32 – fixed displ. pump

Example schematic of manually actuated PVG 32 – fixed displacement pump

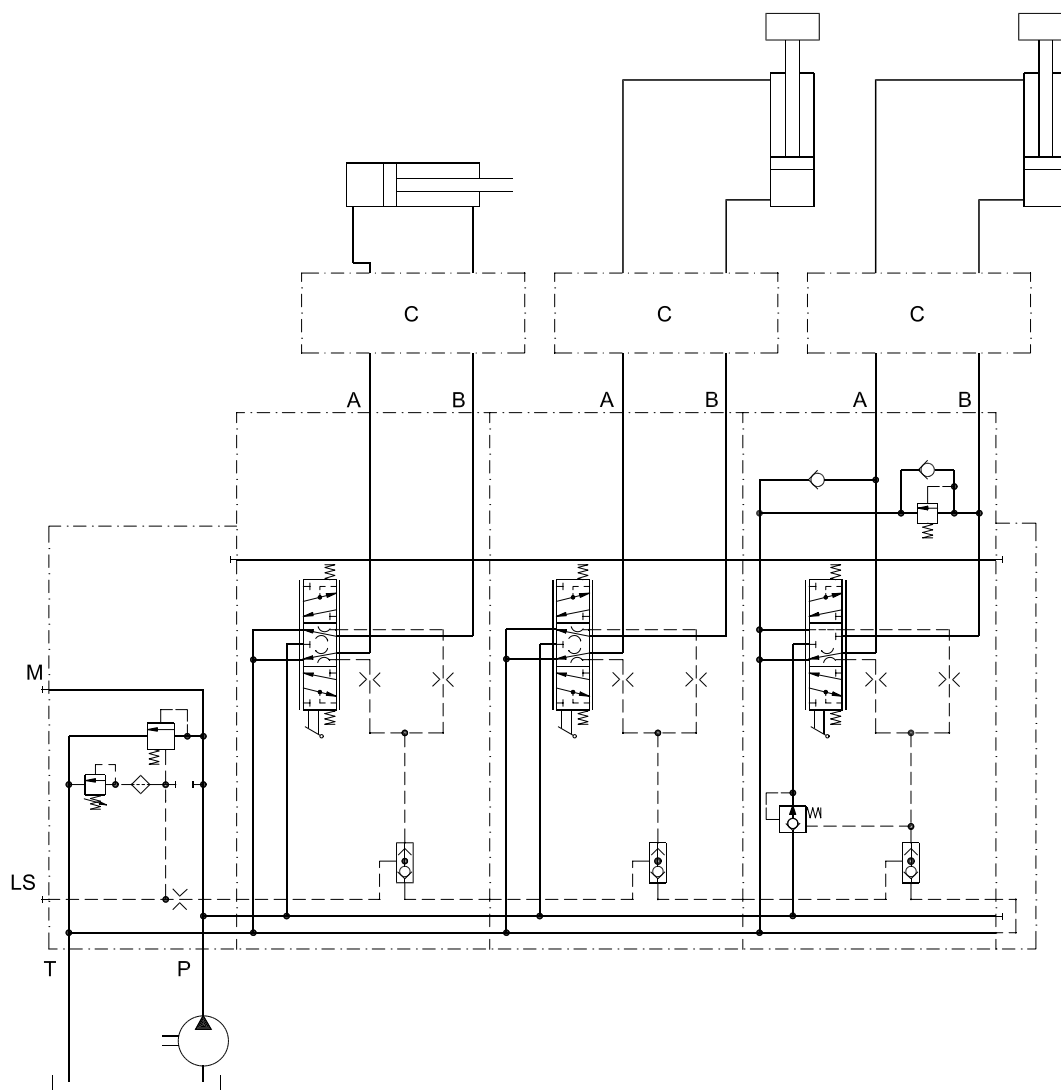

157-55.10

Hydraulic systems

Electrically actuated PVG 32 – variable displ. pump

Example schematic of electrically actuated PVG 32 – variable displacement pump (electrical actuator, shock valves, relief valve)

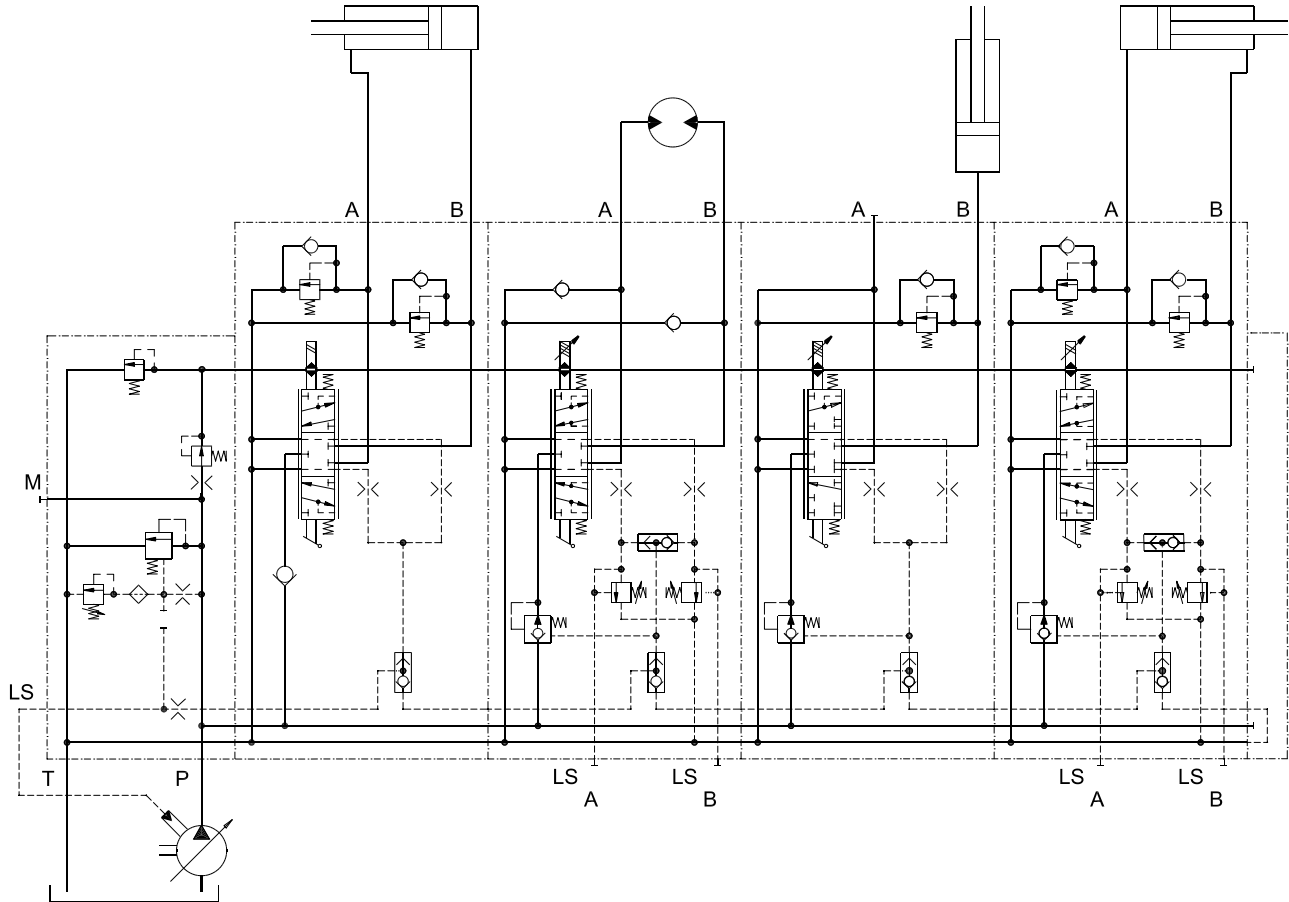

157-56.10

Fluid Specifications

Oil

The main duty of the oil in a hydraulic system is to transfer energy; but it must also lubricate the moving parts in hydraulic components, protect them against corrosion, and transport dirt particles and heat out of the system. It is therefore important to choose the correct oil with the correct additives. This gives normal operation and long working life.

Mineral oil

For systems with this valve Danfoss recommends the use of mineral-based hydraulic oil containing additives: Type HLP (DIN 51524) or HM (ISO 6743/4).

Non-flammable fluids

Phosphate-esters (HFDR fluids) can be used without special precautions. However, dynamic seals must be replaced with FPM (Viton) seals. Please contact the Danfoss Sales Organization if the PVG 32 valve is to be used with phosphate-esters.

The following fluids should only be used according to agreement with the Danfoss Sales Organization for:

- Water-glycol mixtures (HFC fluids)
- Water-oil emulsions (HFB fluids)
- Oil-water emulsions (HFAE fluids)

Filtration

Effective filtration is the most important precondition in ensuring that a hydraulic system performs reliably and has a long working life. Filter manufacturers issue instructions and recommendations. It is advisable to follow these.

System filters

Where demands on safety and reliability are very high a pressure filter with bypass and indicator is recommended. Experience shows that a 10 µm nominal filter (or finer) or a 20 µm absolute filter (or finer) is suitable. It is our experience that a return filter is adequate in a purely mechanically operated valve system. The fineness of a pressure filter must be selected as described by the filter manufacturer so that a particle level of 23/19/16 is not exceeded. The filter must be fitted with pressure gauge or dirt indicator to make it possible to check the condition of the filter. In systems with differential cylinders or accumulators the return filter must be sized to suit the max. return oil flow. Pressure filters must be fitted to suit max. pump oil flow.

Internal filters

The filters built into PVG 32 are not intended to filter the system but to protect important components against large particles. Such particles can appear in the system as a result of pump damage, hose fracture, use of quick-couplings, filter damage, starting up, contamination, etc. The filter in the electrical actuator PVE protecting the solenoid valves has a mesh of 150 µm. Bursting pressure drop for internal filters is 25 bar [360 psi].

Dimensions and ports description

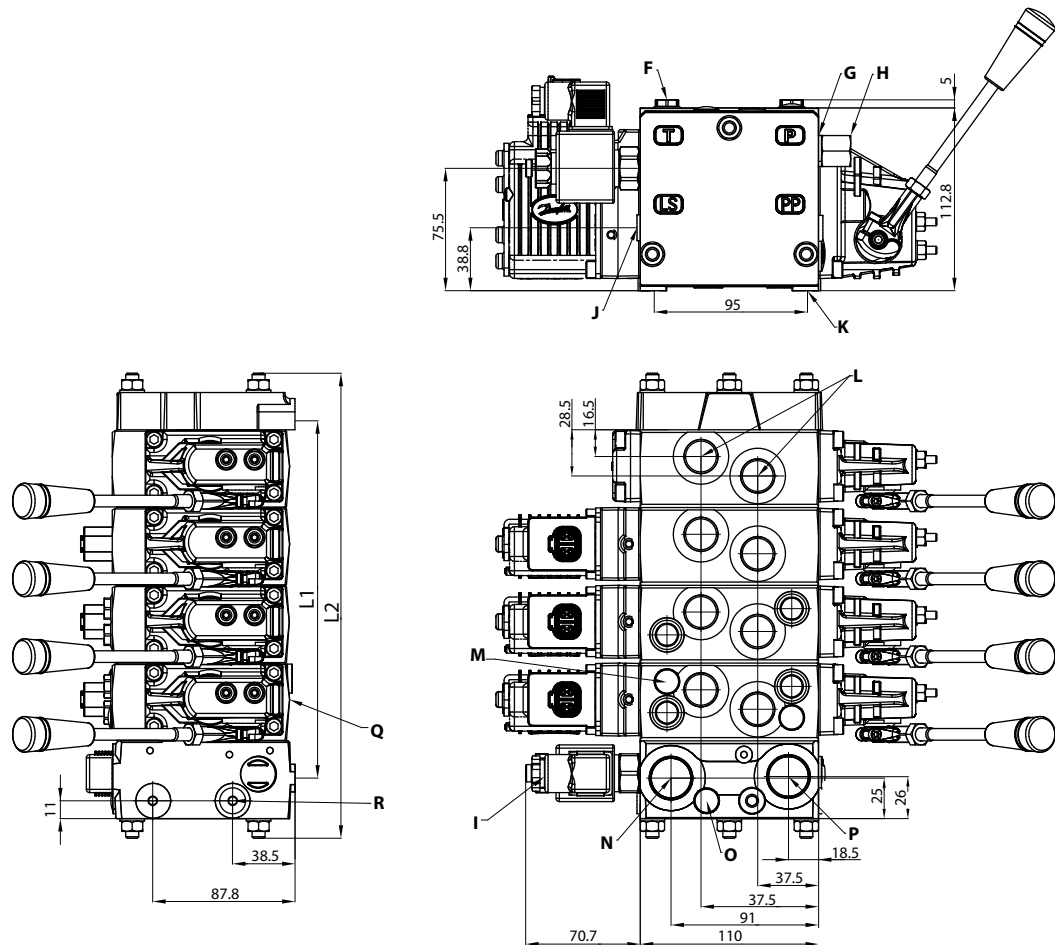

- F** Shock and suction valve, PVL: G $\frac{1}{4}$, 12 mm [$\frac{1}{2}$ -20, 0.47 in] deep
- G** Pressure gauge connection: G $\frac{1}{4}$, 12 mm [$\frac{1}{2}$ -20, 0.47 in] deep
- H** Plug for external pilot oil supply, PVPC: G $\frac{1}{2}$, 12 mm [$\frac{1}{2}$ -20, 0.47 in] deep
- I** Electrical LS unloading valve, PVPX
- J** LS connection: G $\frac{1}{4}$, 12 mm [$\frac{1}{2}$ -20; 0.47 in or $\frac{9}{16}$ -18, 0.5 in] deep
- K** Fixing holes: M8 \times min. 10 mm [$\frac{5}{16}$ -18; 0.39 in] deep
- L** Port A and B: G $\frac{1}{2}$, 14 mm [$\frac{7}{8}$ -14; 0.65 in] deep
- M** LS pressure limiting valve
- N** Tank connection; G $\frac{3}{4}$, 16 mm [$1 \frac{1}{16}$ -12; 0.75 in] deep
- O** Pressure relief valve
- P** Pump connection; G $\frac{1}{2}$, 14 mm [$\frac{7}{8}$ -14; 0.65 in] or G $\frac{3}{4}$, 16 mm [$1 \frac{1}{16}$ -12; 0.75 in] deep
- Q** LS_A and LS_B connections; G $\frac{1}{4}$, 12 mm [$\frac{9}{16}$ -18, 0.5 in] deep
- R** Pilot pressure connection G, Pp

Dimensions and ports description

L1 and L2 dimensions

PVB		1	2	3	4	5	6	7	8	9	10	11	12
L1	mm	82	130	178	226	274	322	370	418	466	514	562	610
	[in]	[3.23]	[5.12]	[7.01]	[8.90]	[10.79]	[12.68]	[14.57]	[16.46]	[18.35]	[20.24]	[22]	[24]
L2	mm	140	189	238	287	336	385	434	483	527	576	622	670
	[in]	[5.51]	[7.44]	[9.37]	[11.30]	[13.23]	[15.16]	[17.09]	[19.02]	[20.95]	[22.87]	[24.5]	[26.4]

PVG 32 section dimensions

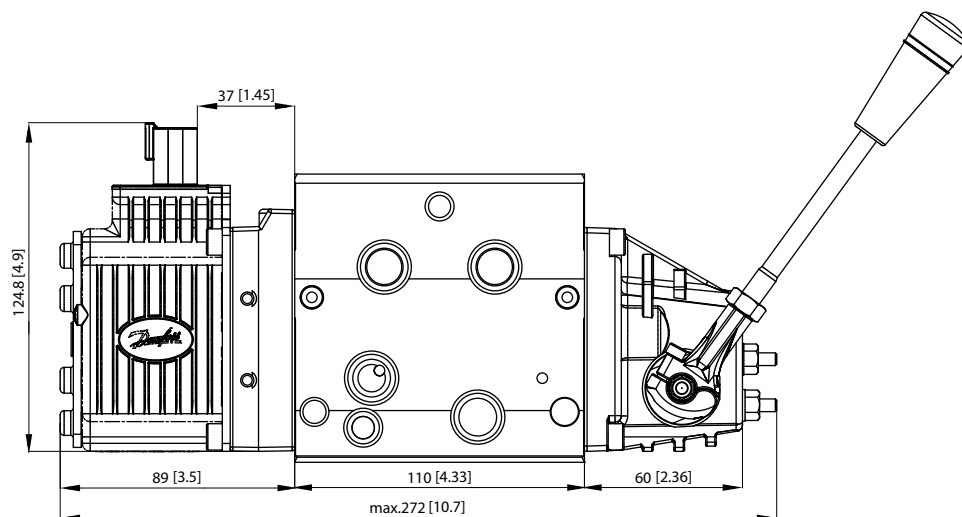

Dimensions and ports description

PVM, control lever positions

Base with an angle of 37.5°

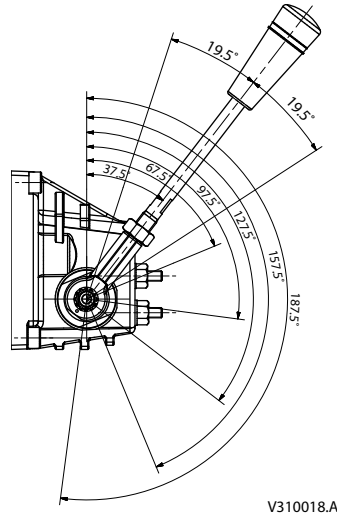

Base with an angle of 22.5°

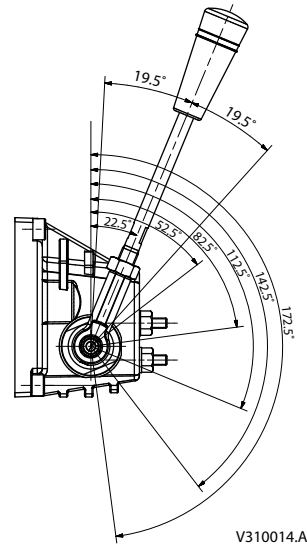

No control lever position	2 x 6
Control lever range	±19.5°
Proportional control lever range	±13.4°
Control lever range – float position	22.3°

The angle of the handle is determined by which side of the handle that is mount towards the base.

- If a 22.5° angle is needed the "dot" on the handle is not visible
- If 37.5° is needed the dot should be visible

Surface treatment

The PVG valve has as standard, an untreated surface. In certain applications, depend on different factors, such as: salty environment, large temperature changes, high humidity, rust can develop on the surface. This will not affect the performance of the PVG valve group. To prevent/reduce rust development, Danfoss recommend the PVG valve group to be painted. Rust on the surface is not seen as a valid complaint issue, neither on painted or unpainted PVG valve groups.

Parts description and code numbers

PVP schematics and code numbers

Symbol	Description	Code number
<p>157-24.11</p>	Open center pump side module for pumps with fixed displacement. For purely mechanically actuated valve groups	P = G ½ T = G ¾ 157B5000
		P = 7/8-14 T = 1 1/16-12 157B5200
		P, T = G ¾ 157B5100
		P, T = 1 1/16-12 157B5300
<p>157-23.11</p>	Closed center pump side module for pumps with variable displacement. For purely mechanically actuated valve groups.	P = G ½ T = G ¾ 157B5001
		P = 7/8-14 T = 1 1/16-12 157B5201
		P, T = G ¾ 157B5101
		P, T = 1 1/16-12 157B5301
<p>157-22.10</p>	Open center pump side module for pumps with fixed displacement. With pilot oil supply for electrically actuated valves.	P = G ½ T = G ¾ 157B5010
		P = 7/8-14 T = 1 1/16-12 157B5210
		P, T = G ¾ 157B5110
		P, T = 1 1/16-12 157B5310
<p>157-21.10</p>	Closed center pump side module for pumps with variable displacement. With pilot oil supply for electrically actuated valves.	P = G ½ T = G ¾ 157B5011
		P = 7/8-14 T = 1 1/16-12 157B5211
		P, T = G ¾ 157B5111
		P, T = 1 1/16-12 157B5311
<p>157-153.11</p>	Open center pump side module for pumps with fixed displacement. With pilot oil supply for electrically actuated valves Connection for electrical LS unloading valve, PVPX (not incl.)	P = G ½ T = G ¾ 157B5012
		P = 7/8-14 T = 1 1/16-12 157B5212
		P, T = G ¾ 157B5112
		P, T = 1 1/16-12 157B5312

Parts description and code numbers

Symbol	Description	Code number
	Closed center pump side module for pumps with variable displacement With pilot oil supply Connection for electrical LS unloading valve, PVPX (not incl.)	P = G ½ T = G ¾ 157B5013
		P = 7/8–14 T = 1 1/16–12 157B5213
		P, T = G ¾ 157B5113
		P, T = 1 1/16–12 157B5313

Connections:

P = G ½ in; 14 mm deep or G ¾ in; 16 mm deep / LS, M = G ¼ in; 12 mm deep / T = G ¾ in; 16 mm deep.

P = 7/8–14; 0.65 in deep or 1 1/16–12; 0.75 in deep / LS, M = ½–20; 0.47 in deep / T = 1 1/16–12; 0.75 in deep.

PVP, pump side modules

Symbol	Description	Code number
	Open center pump side module for pumps with fixed displacement. For mechanical actuated valves. Connection for LS unloading valve, PVPX (not incl)	P, T = G ¾ 157B5102
	Closed center pump side module for pumps with variable displacement. For mechanical actuated valves. Connection for LS unloading valve, PVPX (not incl)	P, T = G ¾ 157B5103
	Open center pump side module for pumps with fixed displacement. With pilot oil supply for electrical actuation and connection for pilot oil pressure Incl. check valve	P, T = G ¾ 157B5180
		P, T = 1 1/16–12 LS connection = 9/16–18 157B5380

Parts description and code numbers

PVP, pump side modules (continued)

Symbol	Description	Code number
<p>157-523.10</p>	<p>Closed center pump side module for pumps with variable displacement. With pilot oil supply for electrical actuation and connection for pilot oil pressure Incl. check valve</p>	<p>P, T = G ¾ 157B5181</p> <p>P, T = 1 1/16–12 LS connection = 9/16–18 157B5381</p>
<p>157-244.10</p>	<p>Open center pump side module for pumps with fixed displacement. With pilot oil supply for hydraulic actuation and connection for pilot oil pressure</p>	<p>P, T = G ¾ 157B5190</p> <p>P, T = 1 1/16–12 LS connection = 9/16–18 157B5390</p>
<p>157-245.10</p>	<p>Closed center pump side module pumps with variable displacement With pilot oil supply for hydraulic actuation and connection for pilot oil pressure</p>	<p>P, T = G ¾ 157B5191</p> <p>P, T = 1 1/16–12 LS connection = 9/16–18 157B5391</p>

Connections:

P, T = G ¾ in; 16 mm deep / LS, M = G ¼ in; 12 mm deep

P, T = 1 1/16–12; 0.75 in deep / LS, M = ½–20; 0.47 in deep.

Parts description and code numbers

PVB, basic module code numbers

PVB without adjustable $LS_{A/B}$ pressure limiting valves

Symbol	Description	Code number		
		No facilities for shock valves A/B	Facilities for shock valves A/B	
	Without load drop check valve and pressure compensator. Can be used where load holding valves prevent oil from flowing back through channel P.	G ½ 14 mm deep	157B6000	157B6030
		7/8-14 0.65 in deep	157B6400	157B6430
	Load drop check valve.	G ½ 14 mm deep	157B6100	157B6130
		7/8-14 0.65 in deep	157B6500	157B6530
	Load drop check valve. $LS_{A/B}$ shuttle valve. To be used with float position spools.	G ½ 14 mm deep	—	157B6136
		7/8-14 0.65 in deep	—	157B6536

Parts description and code numbers

PVB without adjustable $LS_{A/B}$ pressure limiting valves (continued)

Symbol	Description	Code number		
		No facilities for shock valves A/B	Facilities for shock valves A/B	
<p>157-16.10</p>	Non-damped compensator valve	G ½ 14 mm deep	157B6200	157B6230
		7/8-14 0.65 in deep	157B6600	157B6630
<p>V310411.A</p>	Without compensator valve $LS_{A/B}$ shuttle valve	G ½ 14 mm deep	—	11071832
		7/8-14 0.65 in deep	—	—
<p>157-16.10</p>	With damped compensator valve	G ½ 14 mm deep	157B6206	157B6236
		7/8-14 0.65 in deep	11036629	11036630

Parts description and code numbers

PVB with adjustable LS_{A/B} pressure limiting valves

Symbol	Description	Code number		
		No facilities for shock valves A/B	Facilities for shock valves A/B	
<p>157-198.10</p>	With non-damped compensator valve Adjustable LS _{A/B} pressure limiting valves External LS connection port A/B. Also used for float position spools	G ½ 14 mm deep	157B6203	157B6233
		7/8-14 0.65 in deep	157B6603	157B6633
<p>157-17.10</p>	Damped compensator valve Adjustable LS _{A/B} pressure limiting valves External LS connection port A/B	G ½ 14 mm deep	157B6208	157B6238
		7/8-14 0.65 in deep	–	11036631

Parts description and code numbers

PVLA, suction valve (fitted in PVB)

PVLA, suction valve

Symbol	Description	Code number
<p style="text-align: right;">157-15.10</p>	Suction valve for port A and/or B.	157B2001
<p style="text-align: right;">157-223.10</p>	Plug for connecting the nonactive port to tank, when using a single acting spool.	157B2002

PVLP, shock and suction valve (fitted in PVB)

PVLP, shock/ and anti-cavitation valves

Code no. 157B....		2032	2050	2063	2080	2100	2125	2140	2150	2160	2175	2190
Settings	bar	32	50	63	80	100	125	140	150	160	175	190
	[psi]	[460]	[725]	[914]	[1160]	[1450]	[1813]	[2031]	[2175]	[2320]	[2538]	[2755]

Code no. 157B....		2210	2230	2240	2250	2265	2280	2300	2320	2350	2380	2400
Settings	bar	210	230	240	250	265	280	300	320	350	380	400
	[psi]	[3045]	[3335]	[3480]	[3625]	[3845]	[4061]	[4351]	[4641]	[5075]	[5511]	[5801]

Parts description and code numbers

PVLP, shock and suction valve

Symbol	Description
	<p>Shock and suction valve for port A and/or B. (Not adjustable). Lifetime 200.000 actuations.</p>

PVM, PVMD, PVMR, and PVMF code numbers

PVM, mechanical actuation

Symbol	Description	Code number	
		with stop screws	w/o stop screws
	PVM, Standard, spring centered Individual oil flow adjustment to ports A and B	157B3171	157B3191
	Without actuation lever and base. Shaft for mounting of actuation lever	157B3173	157B3193
	PVM, as standard, without actuation lever. With base for mounting of actuation lever	157B3174	157B3194
	PVM, Standard, spring. Individual oil flow adjustment to ports A and B. (Anodized)	157B3184	-

PVMD, cover for mechanical actuation

Symbol	Description	Material	Code No.	Anodized
—	PVMD, Cover for purely mechanically operated valve	aluminium	157B0001	no
		aluminium	157B0009	yes
		cast iron	157B0021	no

PVMR, friction detent

Symbol	Description	Material	Code number	Anodized
	PVMR, Friction detent	aluminium	157B0004	no
		aluminium	157B0012	yes
		cast iron	157B0024	-

Parts description and code numbers

PVMF, mechanical float position

Symbol	Description	Material	Code number	Anodized
 157-208.10	PVMF, Mechanical float position lock	aluminium	157B0005	no
 157-209.10				

PVH, hydraulic actuation code numbers

PVH, hydraulic actuation

Symbol	Description	Material	Code number	Anodized
 157-199.11	PVH, Cover for Hydraulic actuation PVH 9/16-18 UNF	aluminum	157B0007	no
		aluminum	157B0010	yes
		cast iron	157B0014	no
	PVH, Cover for Hydraulic actuation PVH G1/4	aluminum	157B0008	no
		aluminum	157B0011	yes
		cast iron	157B0016	no

PVE actuation literature reference

For the information about the available electrohydraulic actuator variants, please see the following documents overview.

PVE actuation literature reference

Title	Type	Lit. Number
Electrohydraulic Actuators, PVEO/M/A/H/S Series 7	Technical Information	BC00000378
Electrohydraulic Actuators, PVE Series 4 and PVHC	Technical Information	BC00000050
Electrohydraulic Actuators, PVED-CC Series 5 ISObus	Technical Information	BC00000361
Electrohydraulic Actuators, PVED-CC Series 5 CANopen	Technical Information	BC00000354
Electrohydraulic Actuators, PVED-CC Series 4	Technical Information	BC00000107
Electrohydraulic Actuators, PVED-CX Series 4	Technical Information	BC00000068

PVS, end plate

PVS, end plate

Symbol	Description	Mounting threads	Code number	
 V310062.A	PVS, without active elements. No connections	BSP	157B2000	
		SAE	157B2020	
 V310063.A	PVS, without active elements. Max. intermittent LX pressure 250 bar [3625 psi]	G 1/8 10 mm deep	BSP	157B2011
		3/8 in - 24; 0,39 in deep	SAE	157B2021

Parts description and code numbers

PVS, end plate (continued)

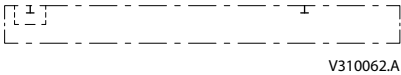
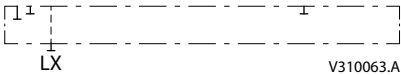
Symbol	Description	Mounting threads	Code number	
 V310062.A	PVS, without active elements Without connections.	BSP	157B2014	
		SAE	157B2004	
 LX V310063.A	PVS, without active elements LX connections. Max. intermittent LX pressure: 350 bar [5075 psi]	G 1/4 10 mm deep	BSP	157B2015
		1/2 in - 20; 0,47 in deep	SAE	157B2005

For mounting threads please see the chapter [Dimensions](#).

PVAS, assembly kit code numbers

PVAS, assembly kit code numbers

Code numbers 157B ____													
No.	0	1	2	3	4	5	6	7	8	9	10	11	12
PVB's	8000	8001	8002	8003	8004	8005	8006	8007	8008	8009	8010	8061	8062
PVB + PVPVM	-	8021	8022	8023	8024	8025	8026	8027	8028	8029	8030	8081	8082
Weight kg [lb]	0.1 [0.2]	0.15 [0.3]	0.25 [0.6]	0.30 [0.7]	0.40 [0.9]	0.45 [1.0]	0.50 [1.1]	0.60 [1.3]	0.65 [1.4]	0.70 [1.6]	0.80 [1.7]	0.85 [1.8]	0.9 [2.0]

PVPX, electrical LS unloaded valve

PVPX, electrical LS unloaded valve

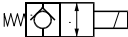
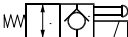
Symbol	Description		Code number
 157-150.10	PVPX, Normally open: LS pressure relieved with no signal to PVPX	12 V	157B4236
		24 V	157B4238
 157-151.10	PVPX, Normally closed: LS pressure relieved with signal to PVPX	12 V	157B4246
		24 V	157B4248
 157-152.10	PVPX, Normally open with manual override: LS pressure relieved with no signal to PVPX Manual override DE-selects LS-pump	12 V	157B4256
		24 V	157B4258
-	Plug		157B5601

Parts description and code numbers

PVPC, plug for external pilot oil supply

PVPC, plug for external pilot oil supply

Symbol	Description		Code number
	PVP, Plug without check valve for open or closed center	G 1/2, 12 mm deep	157B5400
		1/2 in - 20; 0.47 in deep	-
	PVP, Plug with check valve for open center	G 1/2, 12 mm deep	157B5600
		1/2 in - 20; 0.47 in deep	157B5700

Standard FC spools

PVB is with LS _{A/B} shuttle valve							Code number 157B...		PVB is without LS _{A/B} shuttle valve						
Press. compensated flow: l/min [US gal/min]							ISO symbol	Symbol	Press. compensated flow l/min [US gal/min]						
F	E	D	C	B	A	AA			AA	A	B	C	D	E	F
130 [34.3]	100 [26.4]	65 [17.2]	40 [10.6]	25 [6.6]	10 [2.6]	AA 5 [1.3]	 4-way, 3-position Closed neutral position	7005	7000	7001	7002	7003	7004	7006	
7026	7024	7023	7022	7021	7020	7025		7105	7100	7101	7102	7103	7104	7106	
7126	7124	7123	7122	7121	7120	7125	 4-way, 3-position Throttled, open neutral position	7105	7100	7101	7102	7103	7104	7106	

Parts description and code numbers

PVB is with LS _{A/B} shuttle valve							Code number 157B....	PVB is without LS _{A/B} shuttle valve						
-	-	-	-	-	-	-	<p>A P T 157-04.10</p> <p>×A T P T 157-28.10</p> <p>3-way, 3-position Closed neutral position, P → A</p>	-	7200	7201	7202	7203	7204	-
-	-	-	-	-	-	-	<p>B P T 157-05.10</p> <p>B × T P T 157-29.10</p> <p>3-way, 3-position Closed neutral position, P → B</p>	-	-	7301	7302	7303	7304	-
-	7424	7423	7422	7421	-	-	<p>B A P T 157-06.10</p> <p>B A T P T 157-30.10</p> <p>4-way, 3-position Throttled, A → T in neutral position</p>	-	-	7401	7402	7403	7404	7406

Parts description and code numbers

PVB is with LS _{A/B} shuttle valve						Code number 157B....	PVB is without LS _{A/B} shuttle valve							
-	7524	7523	7522	7521	-	-	<p>157-07.10</p>	-	-	7501	7502	7503	7504	-
-	7624	7623	7622	7621	7620	-	<p>157-139.10 157-140.10</p> <p>4-way, 4-position Closed neutral position Float P → B → F</p>	-	-	-	-	-	-	-

Standard FC spools, hydraulic actuation

PVB is with LS _{A/B} shuttle valve						Code number 157B....	PVB is without LS _{A/B} shuttle valve						
Press. compensated flow: l/min [US gal/min]						ISO symbol	Symbol	Press. compensated flow: l/min [US gal/min]					
E	D	C	B	A	AA			AA	A	B	C	D	E
100 [26.4]	65 [17.2]	40 [10.6]	25 [6.6]	10 [2.6]	5 [1.3]			5 [1.3]	10 [2.6]	25 [6.6]	40 [10.6]	65 [17.2]	100 [26.4]
9024	9023	9022	9021	9020	9025	<p>157-02.11 157-117.10</p> <p>4-way, 3-position closed neutral position</p>		9005	9000	9001	9002	9003	9004
9124	9123	9122	9121	9120	9125	<p>157-03.11 157-118.10</p> <p>4-way, 3-position Throttled open neutral position</p>		9105	9100	9101	9102	9103	9104

Parts description and code numbers

FC spools for mechanical float position, PVMF

PVB is with LS _{A/B} shuttle valve							Code number 157B....		PVB is without LS _{A/B} shuttle valve						
Press. compensated flow: l/min [US gal/min]							ISO symbol	Symbol	Press. compensated flow l/min [US gal/min]						
F	E	D	C	B	A	AA			AA	A	B	C	D	E	F
130 [34.3]	100 [26.4]	65 [17.2]	40 [10.6]	25 [6.6]	10 [2.6]	5 [1.3]			5 [1.3]	10 [2.6]	25 [6.6]	40 [10.6]	65 [17.2]	100 [26.4]	130 [34.3]
-	9824	9823	9822	9821	9820	9825	<p>157-09.10</p>		-	-	-	-	-	-	-
							<p>157-454.10</p> <p>4-way, 4 position Closed neutral position P → A → F</p>								
-	9624	623	9622	9621	-	-	<p>157-139.10 157-140.10</p> <p>4-way, 4-position Closed neutral position Float P → B → F</p>		-	-	-	-	-	-	-

FC spools for friction detent, PVMR

PVB is with LS _{A/B} shuttle valve						Code number 157B....		PVB is without LS _{A/B} shuttle valve					
Press. compensated flow: l/min [US gal/min]						ISO symbol	Symbol	Press. compensated flow: l/min [US gal/min]					
E	D	C	B	A	AA			AA	A	B	C	D	E
100 [26.4]	65 [17.2]	40 [10.6]	25 [6.6]	10 [2.6]	5 [1.3]			5 [1.3]	10 [2.6]	25 [6.6]	40 [10.6]	65 [17.2]	100 [26.4]
9724	9723	9722	9721	9720	-	<p>157-02.11 157-117.10</p> <p>4-way, 3-position closed neutral position</p>		-	9700	9701	9702	9703	9704
9734	9733	9732	9731	9730	-	<p>157-03.11 157-118.10</p> <p>4-way, 3-position Throttled open neutral position</p>		-	9710	9711	9712	9713	9714

Parts description and code numbers

FC spools with linear flow characteristic

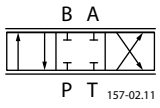
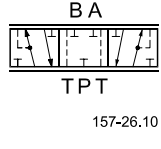
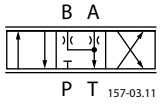
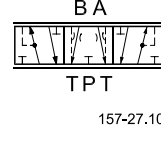
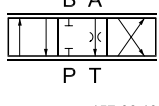
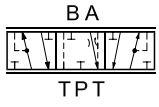
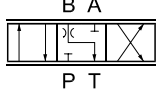
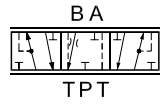
PVB is with LS _{A/B} shuttle valve						Code number 157B...	PVB is without LS _{A/B} shuttle valve						
Press. compensated flow: l/min [US gal/min]						ISO symbol	Symbol	Press. compensated flow: l/min [US gal/min]					
E	D	C	B	A	AA			AA	A	B	C	D	E
100 [26.4]	65 [17.2]	40 [10.6]	25 [6.6]	10 [2.6]	5 [1.3]			5 [1.3]	10 [2.6]	25 [6.6]	40 [10.6]	65 [17.2]	100 [26.4]
9774	9773	9772	9771	-	-	 4-way, 3-position Closed neutral position	 157-26.10	-	9750	9751	9752	9753	9754
9784	9783	9782	9781	-	-	 4-way, 3-position Throttled, open neutral position	 157-27.10	-	9760	9761	9762	9763	9764
-	-	-	-	-	-	 157-06.10  157-30.10 4-way, 3-position Throttled, A → T in neutral position	-	-	-	-	-	-	9794
-	-	-	-	-	-	 157-07.10  157-31.10 4-way, 3-position B → T in neutral position	-	-	-	-	-	-	9804

Standard PC spools

PVB is with LS _{A/B} shuttle valve						Code number 157B...	PVB is without LS _{A/B} shuttle valve						
Press. compensated flow: l/min [US gal/min]						ISO symbol	Symbol	Press. compensated flow: l/min [US gal/min]					
E	D	C	B	A	AA			AA	A	B	C	D	E
100 [26.4]	65 [17.2]	40 [10.6]	25 [6.6]	10 [2.6]	5 [1.3]			5 [1.3]	10 [2.6]	25 [6.6]	40 [10.6]	65 [17.2]	100 [26.4]

Parts description and code numbers

PVB is with LS _{A/B} shuttle valve						Code number 157B....	PVB is without LS _{A/B} shuttle valve					
-	7033	7032	7031	7030	7035	 4-way, 3-position Closed neutral position, PC → A and B	7015	7010	7011	7012	7013	-
7134	7133	7132	7131	7130	7135	 4-way, 3-position Throttled, open neutral position, PC → A and B	7115	7110	7111	7112	7113	-
7064	7063	7062	7061	-	-	 4-way, 3-position Closed neutral position, PC → A	-	7040	7041	7042	7043	7044
7074	7073	7072	7071	-	-	 4-way, 3-position Closed neutral position, PC → B	-	7050	7051	7052	7053	7054
7164	7163	7162	7161	-	-	 4-way, 3-position Throttled, open neutral position, PC → A	-	7150	7151	7152	7153	7154
7174	7173	7172	7171	-	-	 4-way, 3-position Throttled, open neutral position, PC → B	-	7150	7151	7152	7153	7154

Parts description and code numbers

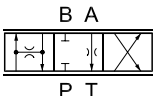
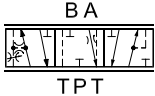
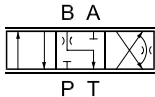
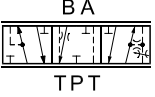
PVB is with LS _{A/B} shuttle valve						Code number 157B....	PVB is without LS _{A/B} shuttle valve						
-	7473	7472	7471	7470	-	 157-149.10	 157-142.10	-	-	-	7452	7453	-
						4-way, 3-position Throttled, A → T neutral position, PC → B							
-	7563	7562	-	-	-	 157-167.10	 157-188.10	-	-	7541	7542	7543	-
						4-way, 3-position Throttled, B → T neutral position, PC → A							

Standard PC spools, hydraulic actuation

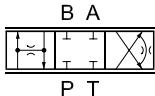
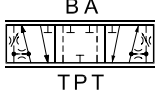
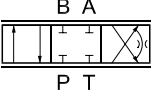
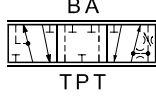
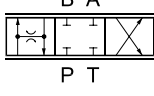
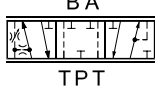
PVB is with LS _{A/B} shuttle valve						Code number 157B....	PVB is without LS _{A/B} shuttle valve						
Press. compensated flow: l/min [US gal/min]						ISO symbol	Symbol	Press. compensated flow: l/min [US gal/min]					
E	D	C	B	A	AA			AA	A	B	C	D	E
100	65	40	25	10	5			5	10	25	40	65	100
[26.4]	[17.2]	[10.6]	[6.6]	[2.6]	[1.3]			[1.3]	[2.6]	[6.6]	[10.6]	[17.2]	[26.4]
-	-	-	-	-	-	 157-143.10	 157-121.10	9015	9010	9011	9012	-	-
						4-way, 3-position Closed neutral position, PC → A and B							
-	-	-	-	-	-	 157-144.10	 157-123.10	-	-	-	9042	9043	9044
						4-way, 3-position Closed neutral position, PC → A							
-	-	-	-	-	-	 157-145.10	 157-122.10	-	-	-	9052	9053	9054
						4-way, 3-position Closed neutral position, PC → B							

Order Specification

PVG 32 order specification

The form can be obtained from the Danfoss Sales Organization. An order form for PVG 32 hydraulic valve is shown on the page [PVG 32 specification sheet](#) on page 66. Both the module selection chart on the previous pages and the order form are divided into fields 0, 1-14, 15, 16, 17, a, b, c, e, f.

Each module has its own field:

0 Inlet section including:	<ul style="list-style-type: none">• Pump side module PVP• Plug for external pilot oil supply PVPC• Electrical LS unloading valve PVPX
1-14 Work section including:	<p>a: Mechanical actuator, PVM (or PVE when option mounted)</p> <p>b: Shock/suction valve, PVLP and suction valve, PVLA</p> <p>c:</p> <ul style="list-style-type: none">• Cover for mechanical actuation, PVMD• Cover for hydraulic actuation, PVH• Electrical actuators, PVE (or PVM when option mounted) <p>e: Main spool PVBS</p> <p>f: Basic module, PVB</p>
15	End plate, PVS
16 Painting	Assembly kit, PVAS

Please state:

- Required code numbers of all modules
 - Required setting (P) for pump side module
 - Required setting of LS_{A/B} pressure limiting valves, see pressure setting guidance below.
-

Reordering

The space at the top right-hand corner of the form is for Danfoss to fill in. The code number for the whole of the specified valve group (PVG No.) is entered here.

In the event of a repeat order all you have to do is enter the number Danfoss has given on the initial confirmation of order.

Order Specification

Pressure setting limits

The maximum setting pressure for the pressure limiting valves LS_A or LS_B depends on the chosen pressure setting for shock valve PVLP. The maximum values recommended to avoid interaction can be read in the following table.

The figures in the table have been calculated according to the following expressions:

- PVLP \leq 150 bar: $LS_{A/B} \leq 0.8 \times P_{PVLP}$
- PVLP > 150 bar: $P_{PVLP} - LS_{A/B} \geq 30$ bar.

Max. pressure setting of LS_A and LS_B valves relative to PVLP shock valve

Pressure for PVLP		Max. for $LS_{A/B}$		Min. for $LS_{A/B}$	
bar	[psi]	bar	[psi]	bar	[psi]
32	[460]	-	-	30 bar]	[435 psi]
50	[725]	40	[580]		
63	[914]	50	[720]		
80	[1160]	64	[930]		
100	[1450]	80	[1160]		
125	[1813]	100	[1450]		
140	[2031]	112	[1625]		
150	[2175]	120	[1740]		
160	[2320]	130	[1885]		
175	[2838]	145	[2100]		
190	[2755]	160	[2320]		
210	[3045]	180	[2610]		
230	[3335]	200	[2900]		
240	[3480]	210	[3045]		
250	[3625]	220	[3190]		
265	[3843]	235	[3408]		
280	[4061]	250	[3625]		
300	[4351]	270	[3915]		
320	[4641]	290	[4205]		
350	5075	320	4641		
380	5511	350	5075		
400	5801	370	5366		

Order Specification

PVG 32 specification sheet

**PVG 32
 Specification Sheet**



Subsidiary / Dealer	PVG No.
Customer	Customer No.
Application	Revision No.

Function	A-port	B-port
0 Inlet		P = bar
1	a	f e
	b	LS _A = bar LS _B = bar
2	a	f e
	b	LS _A = bar LS _B = bar
3	a	f e
	b	LS _A = bar LS _B = bar
4	a	f e
	b	LS _A = bar LS _B = bar
5	a	f e
	b	LS _A = bar LS _B = bar
6	a	f e
	b	LS _A = bar LS _B = bar
7	a	f e
	b	LS _A = bar LS _B = bar
8	a	f e
	b	LS _A = bar LS _B = bar
9	a	f e
	b	LS _A = bar LS _B = bar
10	a	f e
	b	LS _A = bar LS _B = bar
11	a	f e
	b	LS _A = bar LS _B = bar
12	a	f e
	b	LS _A = bar LS _B = bar
13	a	f e
	b	LS _A = bar LS _B = bar
14	a	f e
	b	LS _A = bar LS _B = bar
15 End section		
16 PVAS section		
17 Reserved for painting		

Comments
Filled in by _____ Date _____

Standard and option assembly

The PVG 32 valve group is assembled the way the module selection chart shows if the code number for PVM is written in field 'a', and the code number for PVMD, PVE or PVH in field 'c'.

The valve group is assembled so that the mechanical actuator is mounted on the opposite end of the basic module, if the code number for PVM is written in field 'c' of the order form and the code numbers for PVMD, PVE or PVH in field 'a'.

Products we offer:

- Bent Axis Motors
- Closed Circuit Axial Piston Pumps and Motors
- Displays
- Electrohydraulic Power Steering
- Electrohydraulics
- Hydraulic Power Steering
- Integrated Systems
- Joysticks and Control Handles
- Microcontrollers and Software
- Open Circuit Axial Piston Pumps
- Orbital Motors
- PLUS+1® GUIDE
- Proportional Valves
- Sensors
- Steering
- Transit Mixer Drives

Danfoss Power Solutions is a global manufacturer and supplier of high-quality hydraulic and electronic components. We specialize in providing state-of-the-art technology and solutions that excel in the harsh operating conditions of the mobile off-highway market. Building on our extensive applications expertise, we work closely with our customers to ensure exceptional performance for a broad range of off-highway vehicles.

We help OEMs around the world speed up system development, reduce costs and bring vehicles to market faster.

Danfoss – Your Strongest Partner in Mobile Hydraulics.

Go to www.powersolutions.danfoss.com for further product information.

Wherever off-highway vehicles are at work, so is Danfoss. We offer expert worldwide support for our customers, ensuring the best possible solutions for outstanding performance. And with an extensive network of Global Service Partners, we also provide comprehensive global service for all of our components.

Please contact the Danfoss Power Solution representative nearest you.

Comatrol

www.comatrol.com

Turolla

www.turollaocg.com

Hydro-Gear

www.hydro-gear.com

Daikin-Sauer-Danfoss

www.daikin-sauer-danfoss.com

Local address:

**Danfoss
Power Solutions (US) Company**
2800 East 13th Street
Ames, IA 50010, USA
Phone: +1 515 239 6000

**Danfoss
Power Solutions GmbH & Co. OHG**
Krokamp 35
D-24539 Neumünster, Germany
Phone: +49 4321 871 0

**Danfoss
Power Solutions ApS**
Nordborgvej 81
DK-6430 Nordborg, Denmark
Phone: +45 7488 2222

**Danfoss
Power Solutions Trading
(Shanghai) Co., Ltd.**
Building #22, No. 1000 Jin Hai Rd
Jin Qiao, Pudong New District
Shanghai, China 201206
Phone: +86 21 3418 5200

Danfoss can accept no responsibility for possible errors in catalogues, brochures and other printed material. Danfoss reserves the right to alter its products without notice. This also applies to products already on order provided that such alterations can be made without changes being necessary in specifications already agreed. All trademarks in this material are property of the respective companies. Danfoss and the Danfoss logotype are trademarks of Danfoss A/S. All rights reserved.